

ROBERTS GORDON® CORAYVAC™

**Custom Engineered, Gas-Fired,
Low-Intensity Infrared Heating System**

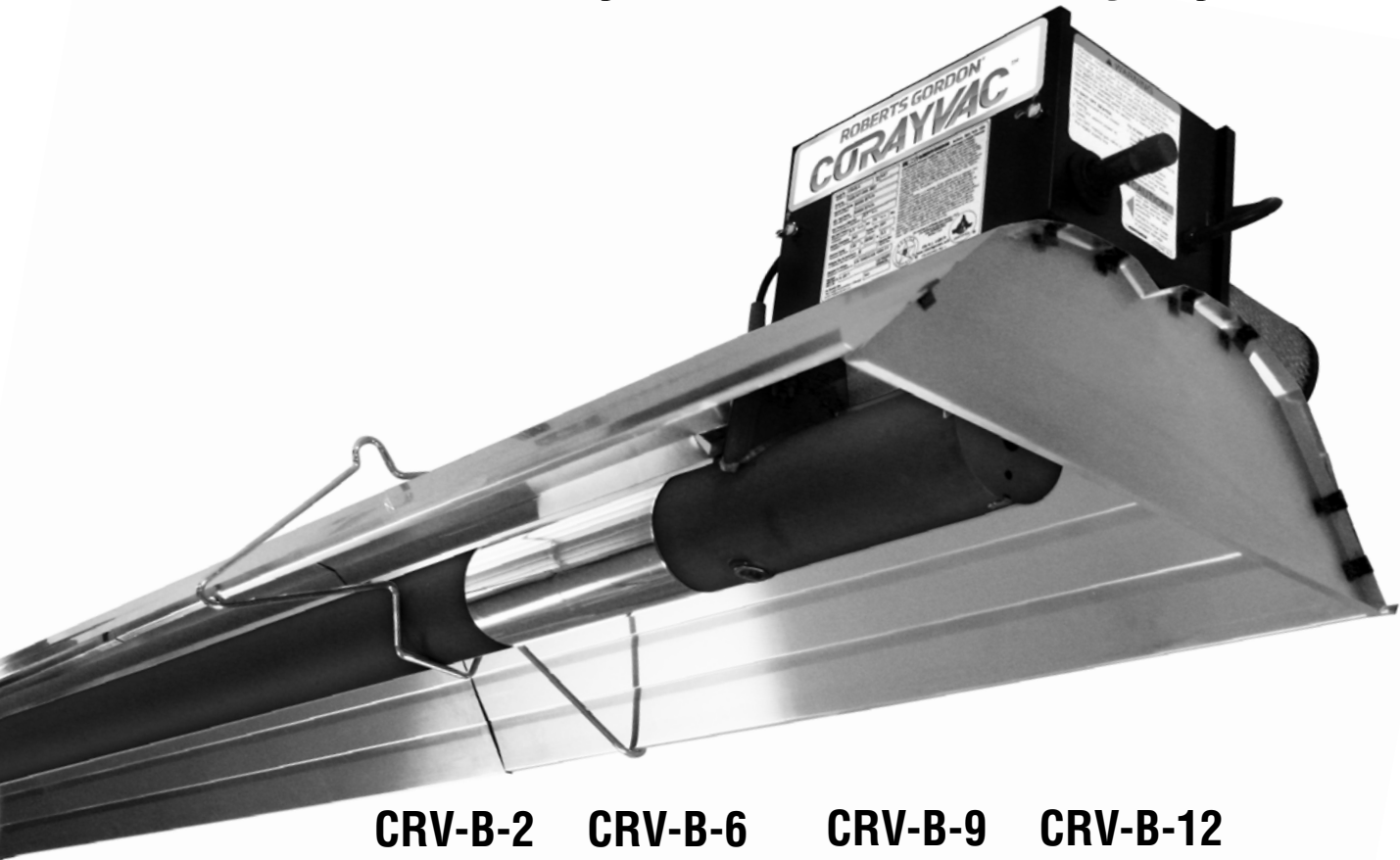

**CRV-B-2 CRV-B-6 CRV-B-9 CRV-B-12
CRV-B-4 CRV-B-8 CRV-B-10 CRV-B-12A**

Design Manual

**All designs must be installed in strict accordance with the CORAYVAC®
Installation, Operation and Service Manual (P/N 127102NA).**



This heater is not certified to meet the requirements of NFPA30A-2012 Section 7.6.6. (maximum tube temperature of 750° F (399° C). Do not install this heater in facilities where major repairs are conducted on compressed natural gas (CNG) or liquefied natural gas (LNG) fueled vehicles.

Roberts-Gordon LLC
1250 William Street
P.O. Box 44
Buffalo, New York 14240-0044
Telephone: +1.716.852.4400
Fax: +1.716.852.0854
Toll Free: 800.828.7450

www.robertsgordon.com

TABLE OF CONTENTS

SECTION 1: Concept	1	9.2 Non-Pressurized	28
SECTION 2: The CRV-Series System	2	9.3 Outside Air System Design Requirements.....	28
2.1 Safety.....	2	SECTION 10: CORAYVAC® Modulating Heating Control	
2.2 Zero Regulator.....	2	Design Requirements	31
2.3 Fuel Savings and Comfort	4	SECTION 11: CRV-Series Equipment Specifications	33
SECTION 3: Clearances to Combustibles	5	11.1 Burner and Burner Controls	33
3.1 Required Clearances to Combustibles.....	5	11.2 Equipment	33
SECTION 4: Sizing and Design Considerations	9		
4.1 Radiant Adjustment to Heat Loss	9		
4.2 Radiant Height Adjustment Factor	9		
4.3 Selecting the Burners	10		
4.4 Radiant Distribution	10		
SECTION 5: Flow Loading	12		
5.1 Radiant Branch Flow	12		
5.2 Pump Capacity	14		
5.3 Tailpipe Flow	14		
SECTION 6: Radiant Tube and Tailpipe	15		
6.1 Radiant Tube Length.....	15		
6.2 Tailpipe.....	15		
6.3 Design Parameters	16		
6.4 CRV-Series Design Methods	16		
6.5 Tailpipe Design Method	18		
SECTION 7: Example CRV-Series System Layouts	21		
7.1 Example System Layout (Option 1)	21		
7.2 Example System Layout (Option 2)	22		
7.3 Example System Layout (Option 3)	22		
7.4 Example System Layout (Option 4)	23		
7.5 Example System Layout (Option 5)	23		
7.6 Example System Layout (Option 6)	24		
7.7 Example System Layout (Option 7, 8 and 9).....	25		
SECTION 8: Control Methods	26		
8.1 ROBERTS GORDON® CORAYVAC® Heating			
Control	26		
8.2 CORAYVAC® Modulating Heating Control			
(CRV-B 6/8/9/10/12/12A only)	26		
8.3 CORAYVAC® Modulating Controls.....	26		
8.4 SPST Transformer Relay Kit (P/N 90417600K).....	27		
8.5 SPDT Transformer Relay (P/N 90436300).....	27		
8.6 Pressure Switch	27		
SECTION 9: Air Supply System	28		
9.1 Pressurized	28		

There are references in this manual to various trademarks. All trademarks mentioned herein, whether registered or not, are the property of their respective owners. Roberts-Gordon LLC is not sponsored by or affiliated with any of the trademark or registered trademark owners, and make no representations about them, their owners, their products or services. Roberts-Gordon LLC is not sponsored by or affiliated with BACnet®, LonWorks® or MODBUS®.

© 2016 Roberts-Gordon LLC

All rights reserved. No part of this work covered by the copyrights herein may be reproduced or copied in any form or by any means - graphic, electronic, or mechanical, including photocopying, recording, taping or information storage and retrieval systems - without the written permission of Roberts-Gordon LLC.

TABLE OF FIGURES

Figure 1: Assembly Overview (Two Branch System Shown).....	3
Figure 2: Standard Reflector	6
Figure 3: One Side Reflector.....	6
Figure 4: Two Side Reflectors	6
Figure 5: Universal Shield, Position 1	7
Figure 6: Universal Shield, Position 2	7
Figure 7: Universal Shield, Position 3	7
Figure 8: 2-Foot Deco Grille	8
Figure 9: Barrier Shield	8
Figure 10: Protective Grille	8
Figure 11: Radiant Distribution (Average Coverage)	11
Figure 12: Radiant Distribution (Increased Coverage)	11
Figure 13: Radiant Distribution (Heavy Coverage).....	11
Figure 14: Burner Flow Units	13
Figure 15: Vacuum Loss Curve for 4" Shared Tailpipe.....	14
Figure 16: Tube Length vs. Efficiency.....	16
Figure 17: Possible Damper Coupling Locations	20
Figure 18: Example System Layout (Option 1).....	21
Figure 19: Example System Layout (Option 2).....	22
Figure 20: Example System Layout (Option 3).....	22
Figure 21: Example System Layout (Option 4).....	23
Figure 22: Example System Layout (Option 5).....	23
Figure 23: Example System Layout (Option 6).....	24
Figure 24: Example System Layout (Option 7).....	24
Figure 25: Example System Layout (Option 8).....	24
Figure 26: Example System Layout (Option 9).....	25
Figure 27: Air Supply System Capacity by Duct Length and Diameter	29
Figure 28: Outside Air Blower.....	29
Figure 29: Sample Layout for Pressurized Outside Air Systems	30

SECTION 1: CONCEPT

The concept of CRV-Series is easy to understand. However, it means discarding old ideas because CRV-Series is a different kind of heating system.

CRV-Series is a gas-fired, vacuum-operated, low-intensity infrared heating system incorporating a patented incremental burner system.

NOTE: This heater is designed for heating nonresidential indoor spaces. Do not install in residential spaces. This heater is not certified to meet the requirements of NFPA30A-2012 Section 7.6.6. (maximum tube temperature of 750 °F (399 °C)). Do not install this heater in facilities where compressed natural gas (CNG) or liquid natural gas (LNG) are present.

Gas-Fired means it uses clean-burning Natural or Propane gas.

Vacuum-Operated means that the pump draws all the products of combustion through the system and expels them outdoors.

Low-Intensity means the radiant surfaces of the tubes do not glow red; instead they operate at a lower temperature (less than 1200° F or 649° C) and radiate heat at lower intensity per square foot of radiating surface. Area coverage is provided by long runs of 4" (10 cm) O.D. tubing which hang from the ceiling or roof supports. Reflectors direct the radiant heat downward to occupied areas.

Radiant refers to the heat radiated by the CRV-Series system. Because this heat is in the form of infrared rays, it does not directly heat the air. Instead, the rays heat objects such as floors, people, walls, cars, machines, tools, etc. The warm objects, in turn, heat the air through convection.

Incremental Burner System means that several burners can operate in-series and fire into the same run of steel tube that carries the combustion gases from upstream burners. Each of these burners in a radiant branch may have different firing rates; also, the space between burners may vary. This allows the designer to match heat gain to heat loss for each area of the building. Firing burners in-series provides higher thermal and radiant efficiency.

In a properly designed low-intensity radiant system, the occupants should be barely aware of the radiant heat when the system is firing. They will feel little or no change when the thermostat is satisfied and the system is not firing. This combines with warm floors,

warm walls and draft-free operation to improve the mean radiant temperature of the space. This is the key to the exceptional comfort and fuel efficiency provided by the CRV-Series system.

SECTION 2: THE CRV-SERIES SYSTEM

A CRV-Series system consists of one pump, a control system, and a number of burners, *see Page 3, Figure 1*. It also includes an extended tube surface (4" (10 cm) steel tubing) covered by highly efficient reflectors to direct the radiant heat downward to the floor. The tubing nearest the burners radiates with the most intensity and is called **radiant tube**. This should be located over areas with the greatest heat loss. The rest of the tubing surface (located between the radiant tube and the pump) radiates with less intensity and is called **tailpipe**. This can be located in areas with lower heat loss.

While it is important to locate radiant tubes over areas with high heat loss, such as the perimeter of the building, it is not essential to cover all areas directly with radiant heat. Center areas (away from external walls) and other areas of low heat loss can be adequately heated without direct coverage as long as the input of the system is adequate for the total building heat loss. However, to achieve the highest degree of comfort and fuel savings, it is recommended that the CRV-Series system be located to provide as complete and even a distribution as is practical. In addition, several different reflector and shield configurations are available to direct the radiant heat to or away from desired areas.

Page 3, Figure 1 illustrates the components of a typical CRV-Series system. The system shown is a four burner system composed of two branches. A **branch** consists of a single run of tubing, including an end burner, followed by any burners downstream. A branch ends at a tee or a cross (where other branches connect). For a single branch system, the branch ends at the pump.

2.1 Safety

Safety is a prime consideration of CRV-Series. First, there is a pre-purge of the complete tube network prior to flame ignition. Then, to ensure that there will be no gas flow unless the pump is operating, a pressure switch located at the pump must activate prior to ignition. After the pressure switch has closed, there are two valves in-series in each burner that must be energized, as well as a zero regulator. Additionally, slow opening gas valves provide smooth ignition and enhance reliability. Once the thermostat has been satisfied, the burners turn off and the pump continues to run for two minutes to purge the entire system of flue gases.

With CRV-Series, all equipment and controls are C.S.A. design certified, both as individual parts and also as a complete heating system. Also, individual electrical component parts are listed as applicable.

2.2 Zero Regulator

CRV-Series uses a 100% pre-mix burner with the input dependent on system vacuum. With no vacuum, the zero regulator prevents gas flow. When vacuum is present, the burner fires and input increases as vacuum increases. As the input increases, the amount of air also increases. Over the normal range of operating vacuum, the gas/air ratio is essentially linear.

This unique and patented feature provides optimum combustion conditions at all times. Combustion conditions are unaffected by fluctuations in fuel pressure, vacuum, dirty air filters, changes in atmospheric pressure, wind velocity or other climate conditions.

FIGURE 1: Assembly Overview (Two Branch System Shown)

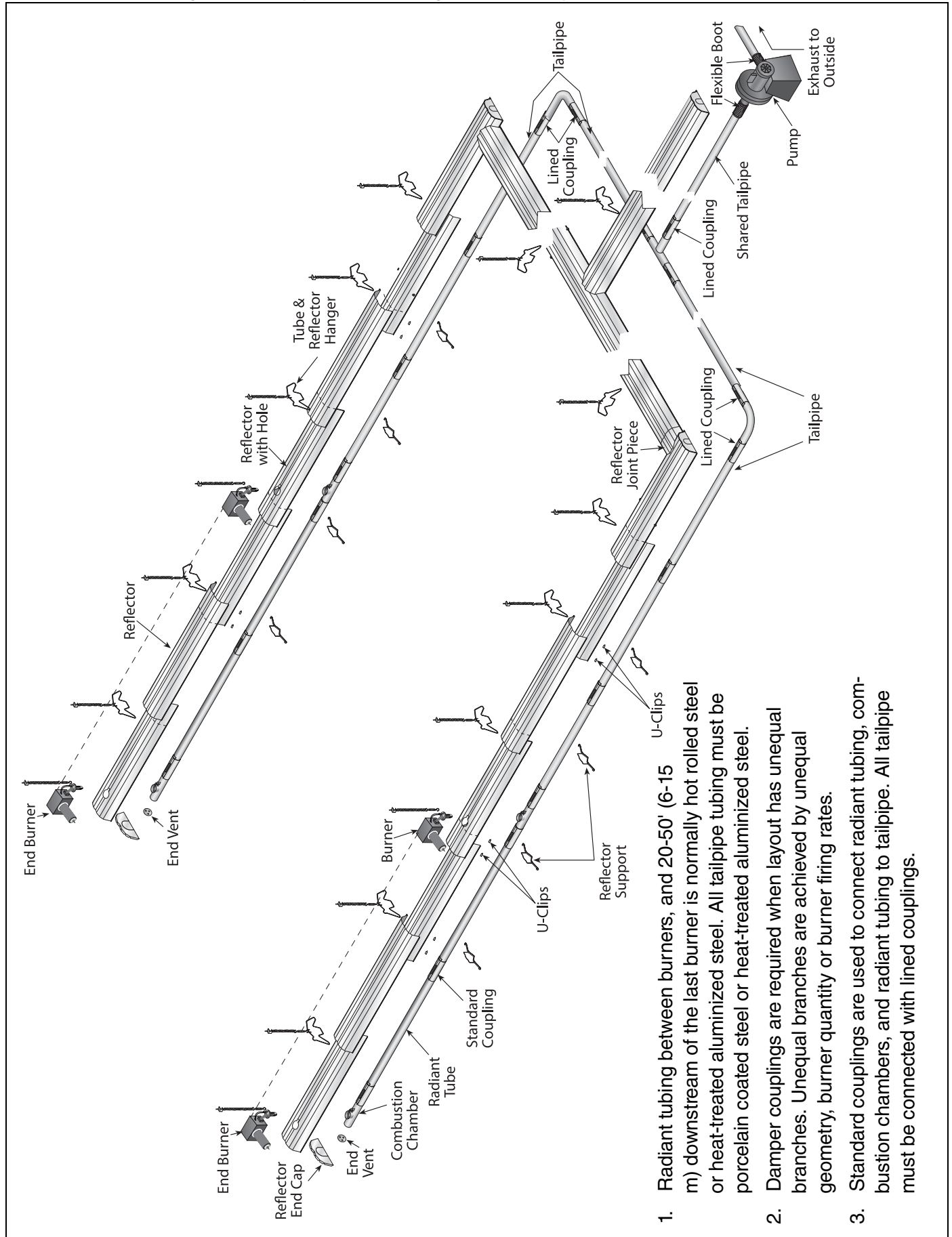

2.3 Fuel Savings and Comfort

Space heating can be accomplished with less input capacity when a radiant heating system is utilized, rather than with a conventional convective heating system. Why is this so?

A conventional, convective heating system, such as a unit heater or central furnace works by heating the air, which then indirectly heats the area and occupants. CRV-Series utilizes infrared energy to heat objects, people and surfaces directly, not the air. The warm objects and floor create a heat reservoir, which then re-radiates to the surroundings and also heats the air by convection.

The radiant energy received by the occupants, directly from the heater or indirectly from the surroundings via re-radiation, serves to increase the Mean Radiant Temperature (MRT) of the space. In a manner similar to direct sunlight, the increased MRT allows the occupant to perceive a comfort condition at a reduced air temperature. The resulting reduced air temperature within the space provides the following fuel-saving advantages:

- Reduced stratification of air in the space.
- Reduced transmission heat loss due to lower temperature inside than assumed design condition.
- Reduced air change heat loss, to the extent that exfiltration through cracks or openings near the roof will be decreased because of decreased stack effect.
- Decreases the actual degree days experienced.

SECTION 3: CLEARANCES TO COMBUSTIBLES

3.1 Required Clearances to Combustibles

Clearances are the required distances that combustible objects must be away from the heater to prevent serious fire hazards. Combustibles are materials, which may catch on fire and include common items such as wood, paper, rubber, fabric, etc. **Maintain clearances to combustibles at all times for safety.**

Clearances for all heater models are located on the burner assembly and on Page 6, Figure 3 through Page 8, Figure 10 in this manual. Check the clearances on each burner for the model heater being installed to make sure the product is suitable for your application and the clearances are maintained. Read and follow the safety guidelines below:

- Keep gasoline or other combustible materials including flammable objects, liquids, dust or vapors away from this heater or any other appliance.
- The stated clearances to combustibles represents a surface temperature of 90° F (32° C) above room temperature. Building materials with a low heat tolerance (such as plastics, vinyl siding, canvas, tri-ply, etc) may be subject to degradation at lower temperatures. It is the installer's responsibility to assure that adjacent materials are protected from degradation.
- Maintain clearances from heat sensitive equipment and workstations.
- Maintain clearances from vehicles parked below the heater.
- Maintain clearances from swinging and overhead doors, overhead cranes, vehicle lifts, partitions, storage racks, hoists, building construction, etc.
- In locations used for the storage of combustible materials, signs must be posted to specify the maximum permissible stacking height to maintain required clearances from the heater to the combustibles. Signs must be posted adjacent to the heater thermostat. In the absence of a thermostat, signs must be posted in a conspicuous location.
- Consult local Fire Marshal, Fire Insurance Carrier or other authorities for approval of proposed installation when there is a possibility of exposure to combustible airborne materials or vapors.
- Hang heater in accordance to the minimum suspension requirements.
- If the radiant tubes must pass through the building structure, be sure that adequate sleeving and fire stop is installed to prevent scorching and/or fire hazard.



- NOTE:**
1. All dimensions are from the surfaces of all tubes, couplings, elbows, tees and crosses.
 2. Clearances B, C and D can be reduced by 50% after 25' (7.5 m) of tubing downstream from where the combustion chamber and the tube connect.

FIGURE 2: STANDARD REFLECTOR

	Model	(inches)				(centimeters)			
		A	B	C	D	A	B	C	D
	CRV-B-2	4	20	48	20	11	51	122	51
	CRV-B-4	4	20	48	20	11	51	122	51
	CRV-B-6	4	20	48	20	11	51	122	51
	CRV-B-8	4	20	48	20	11	51	122	51
	CRV-B-9	4	36	60	36	11	92	153	92
	CRV-B-10	4	36	60	36	11	92	153	92
	CRV-B-12	4	36	60	36	11	92	153	92
	CRV-B-12A	4	36	60	36	11	92	153	92

FIGURE 3: ONE SIDE REFLECTOR

	Model	(inches)				(centimeters)			
		A	B	C	D	A	B	C	D
	CRV-B-2	4	12	56	20	11	31	143	51
	CRV-B-4	4	12	56	20	11	31	143	51
	CRV-B-6	4	12	56	20	11	31	143	51
	CRV-B-8	4	12	56	20	11	31	143	51
	CRV-B-9	4	12	60	42	11	31	153	107
	CRV-B-10	4	12	60	42	11	31	153	107
	CRV-B-12	4	12	60	42	11	31	153	107
	CRV-B-12A	4	12	60	42	11	31	153	107

FIGURE 4: TWO SIDE REFLECTORS

	Model	(inches)				(centimeters)			
		A	B	C	D	A	B	C	D
	CRV-B-2	4	12	56	12	11	31	143	31
	CRV-B-4	4	12	56	12	11	31	143	31
	CRV-B-6	4	12	56	12	11	31	143	31
	CRV-B-8	4	12	56	12	11	31	143	31
	CRV-B-9	4	12	60	12	11	31	153	31
	CRV-B-10	4	12	60	12	11	31	153	31
	CRV-B-12	4	12	60	12	11	31	153	31
	CRV-B-12A	4	12	60	12	11	31	153	31

- NOTE:** 1. All dimensions are from the surfaces of all tubes, couplings, elbows, tees and crosses.
2. Clearances B, C and D can be reduced by 50% after 25' (7.5 m) of tubing downstream from where the combustion chamber and the tube connect.

FIGURE 5: UNIVERSAL SHIELD, POSITION 1

	Model	(inches)				(centimeters)			
		A	B	C	D	A	B	C	D
	CRV-B-2	4	12	12	12	11	31	31	31
	CRV-B-4	4	12	12	12	11	31	31	31
	CRV-B-6	4	12	12	12	11	31	31	31
	CRV-B-8	4	12	12	12	11	31	31	31
	CRV-B-9	8	18	24	18	21	46	61	46
	CRV-B-10	8	18	24	18	21	46	61	46
	CRV-B-12	8	18	24	18	21	46	61	46
	CRV-B-12A	8	18	24	18	21	46	61	46

FIGURE 6: UNIVERSAL SHIELD, POSITION 2

	Model	(inches)				(centimeters)			
		A	B	C	D	A	B	C	D
	CRV-B-2	4	24	48	24	11	61	122	61
	CRV-B-4	4	24	48	24	11	61	122	61
	CRV-B-6	4	24	48	24	11	61	122	61
	CRV-B-8	4	24	48	24	11	61	122	61
	CRV-B-9	4	36	48	36	11	92	122	92
	CRV-B-10	4	36	48	36	11	92	122	92
	CRV-B-12	4	36	48	36	11	92	122	92
	CRV-B-12A	4	36	48	36	11	92	122	92

FIGURE 7: UNIVERSAL SHIELD, POSITION 3

	Model	(inches)				(centimeters)			
		A	B	C	D	A	B	C	D
	CRV-B-2	4	12	56	30	11	31	143	77
	CRV-B-4	4	12	56	30	11	31	143	77
	CRV-B-6	4	12	56	30	11	31	143	77
	CRV-B-8	4	12	56	30	11	31	143	77
	CRV-B-9	8	12	60	42	21	31	153	107
	CRV-B-10	8	12	60	42	21	31	153	107
	CRV-B-12	8	12	60	42	21	31	153	107
	CRV-B-12A	8	12	60	42	21	31	153	107

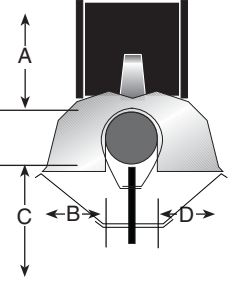
- NOTE:** 1. All dimensions are from the surfaces of all tubes, couplings, elbows, tees and crosses.
 2. Clearances B, C and D can be reduced by 50% after 25' (7.5 m) of tubing downstream from where the combustion chamber and the tube connect.

FIGURE 8: 2-FOOT DECO GRILLE

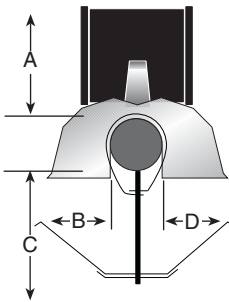
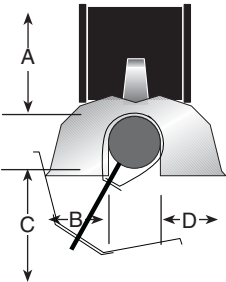
	Model	(inches)				(centimeters)			
		A	B	C	D	A	B	C	D
	CRV-B-2	4	12	48	12	11	31	122	31
	CRV-B-4	4	12	48	12	11	31	122	31
	CRV-B-6	4	12	48	12	11	31	122	31
	CRV-B-8	4	12	48	12	11	31	122	31
	CRV-B-9	4	18	56	18	11	46	143	46
	CRV-B-10	4	18	56	18	11	46	143	46
	CRV-B-12	4	18	56	18	11	46	143	46
	CRV-B-12A	4	18	56	18	11	46	143	46

FIGURE 9: BARRIER SHIELD

	Model	(inches)				(centimeters)			
		A	B	C	D	A	B	C	D
	CRV-B-2	4	12	12	12	11	31	31	31
	CRV-B-4	4	12	12	12	11	31	31	31
	CRV-B-6	4	12	12	12	11	31	31	31
	CRV-B-8	4	12	12	12	11	31	31	31
	CRV-B-9	- UNAPPROVED -				- UNAPPROVED -			
	CRV-B-10	- UNAPPROVED -				- UNAPPROVED -			
	CRV-B-12	- UNAPPROVED -				- UNAPPROVED -			
	CRV-B-12A	- UNAPPROVED -				- UNAPPROVED -			

FIGURE 10: PROTECTIVE GRILLE

	Model	(inches)				(centimeters)			
		A	B	C	D	A	B	C	D
	CRV-B-2	4	20	48	20	11	51	122	51
	CRV-B-4	4	20	48	20	11	51	122	51
	CRV-B-6	4	20	48	20	11	51	122	51
	CRV-B-8	4	20	48	20	11	51	122	51
	CRV-B-9	4	36	60	36	11	92	153	92
	CRV-B-10	4	36	60	36	11	92	153	92
	CRV-B-12	4	36	60	36	11	92	153	92
	CRV-B-12A	4	36	60	36	11	92	153	92

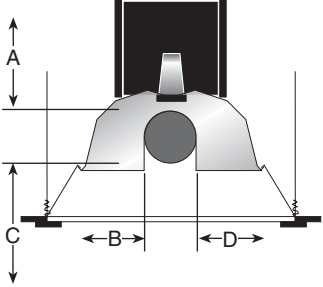
SECTION 4: SIZING AND DESIGN CONSIDERATIONS

The building heat loss must be calculated in accordance to accepted energy load calculation methods. ASHRAE (American Society of Heating, Refrigeration and Air-Conditioning Engineers) offers in-depth information that is useful in calculating energy loads. The CRV-Series system input is determined in concert with the required radiant adjustment to heat loss and height adjustment factors.

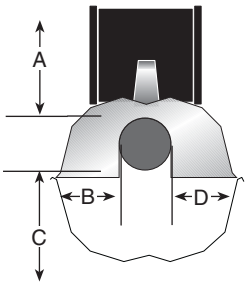
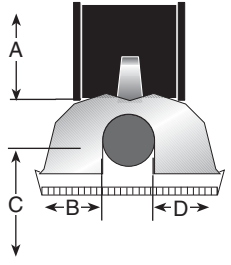
4.1 Radiant Adjustment to Heat Loss

The practice of applying an adjustment factor to heat loss calculations for radiant heating systems is well known within the radiant heating industry, having been used by manufacturers for over 30 years. A number of studies have been conducted to identify the values of the adjustment factor in the range of 0.8 to 0.85 depending on efficiency (higher efficiency uses lower factor). This adjustment can be more thoroughly understood when considering the following radiant effect issues:

- Infrared energy heats objects, not the air.
- Lower ambient temperatures reduce the amount of air infiltration.
- Less air stratification with radiant heat.
- Lower ambient air temperatures reduce the transmission heat loss through walls and roof.
- Elevated floor temperature provides a thermal reserve capacity.
- Increased mean radiant temperature allows occupants to perceive thermal comfort at the reduced air temperature.

Each of these issues impacts favorably on the reduction of the installed capacity of the radiant heating system. This fact, together with the realization that the standard ASHRAE heat loss calculation methods (particularly the transmission heat loss coefficients) have been developed specifically for conventional hot air systems, demonstrates the need for the heat loss adjustment factor.

- In general, a .80 adjustment factor should be used for CRV-Series systems.

4.2 Radiant Height Adjustment Factor

As discussed above, the installed input capacity of radiant heating systems is typically reduced as compared to the calculated heat loss due to the radiant effects associated with a properly designed radiant

heating system. The ability of a radiant system to provide the advantages of these radiant effects rests largely with the ability of this system to establish a reserve heat capacity in the floor. Without this reserve capacity, radiant comfort cannot be achieved. (The exception is station heating/spot heating applications where sufficiently high levels of direct radiation are received from the heater.) The height adjustment factor is a means to insure adequate floor level radiant intensity to “charge” the floor heat reservoir.

Proportionately larger wall surfaces also remove energy from the floor to a larger degree, decreasing the heat reservoir.

The increased input capacity recommended by a height adjustment factor is not extraneous as compared to the heat loss calculation. Rather, it is a realization that in order to maintain radiant comfort conditions (and the economic benefits), a minimum radiant level must be maintained at the floor.

It is recommended that an adjustment to the heat loss of 1% per foot (3% per meter) for mounting heights above 20' (6 m), be added up to 60' (18 m). Above this height, additional correction overstates the BTU requirement as determined by the heat loss.

EXAMPLE 1:

Given a building with a calculated heat loss of 350,000 (Btu/h), what is the installed capacity required of a CORAYVAC® system mounted at 30' (9 m)?

CORAYVAC® Installed Capacity = Heat Loss x Radiant Adjustment x Height Adjustment

For CORAYVAC® systems, a .80 radiant adjustment factor is used.

The height adjustment is 1% per foot over 20' (3% per meter over 6 meters), or 1.10.

∴ CORAYVAC® Installed Capacity = 350,000 (Btu/h) x .80 x 1.10 = **308,000 (Btu/h)**

A 12% reduction in installed capacity vs. a conventional heating system.

EXAMPLE 2:

Given a building with a calculated heat loss of 500,000 Btu/h, what is the installed capacity required of a CRV-Series system mounted at 50' (15 m)?

CORAYVAC® Installed Capacity = Heat Loss x Radiant Adjustment x Height Adjustment.

For CORAYVAC® systems, a .80 radiant adjustment factor is used.

The height adjustment is 1% per foot over 20' (3% per meter over 6 meters), or 1.30.

∴ CORAYVAC® Installed Capacity = 500,000 (Btu/h) x .80 x 1.30 = **520,000 (Btu/h)**.

Note in *Example 2*, if equipment had been conventionally sized based on thermal output only, a nearly identical input requirement would result. For mounting heights above 60' (18 m), no further correction is generally necessary if the floor level radiant intensity is sufficient to establish a reserve capacity (hence, radiant comfort), and the heat loss requirement is satisfied based on thermal output.

Due to the complexity of installations with mounting heights over 60' (18 m), it is advisable to contact Roberts-Gordon for further information regarding the specific application.

4.3 Selecting the Burners

The number of burners and input for each must be specified in the design layout. The following factors should be considered when selecting burner input:

- Heat gain and distribution required.
- Mounting height.
- Flow loading restrictions.
- Length of radiant branches.
- Distance required between burners.
- Desired radiation intensity.

In general, lower burner inputs can be used for lower mounting heights and where lower heat gains are required. Higher burner inputs are used primarily with higher mounting heights and where high heat gain is required.

The number of burners required can be calculated by dividing the input rating of the selected sizes into the

calculated CRV-Series system required installed capacity.

4.4 Radiant Distribution

Radiant heat distribution at occupant level must be considered in the burner and design selection process.

Distribution of heat between radiant branches at floor level is more critical at the perimeter of buildings. This is where the heat loss is highest. Therefore, it may be possible to combine different applications of distribution within the same building. The following figures show three different applications of rules to determine distribution.

4.4.1 Radiant Distribution (Average Coverage)

The aim of this distribution is to provide average or lighter than average radiant intensity and works well for general building heating. See *Page 11, Figure 11*. The distance between radiant branches can vary between 2.5 to 4 (or more) times the mounting height.

This distribution is commonly used in applications such as warehouses and lower heat loss areas of a building.

Lighter coverage can be used in areas where occupant traffic is low.

4.4.2 Radiant Distribution (Increased Coverage)

The aim of this distribution is to provide continuous radiant intensity. See *Page 11, Figure 12*. The distance between radiant branches is about 2 times the mounting height.

This distribution is commonly used in areas bordering high heat loss areas or areas requiring increased radiant intensity to achieve occupant comfort.

4.4.3 Radiant Distribution (Heavy Coverage)

The aim of this distribution is to provide increased radiant intensity in areas that range from sedentary work to spot heating for loading docks. See *Page 11, Figure 13*. The y dimensions in the diagram is the height above floor level where overlap of the radiant output will occur.

In practice, $y = 6'$ (1.83 m) is commonly used in areas where occupant comfort doing sedentary work is an important factor. In loading bays, spot heating and areas of high heat loss, the horizontal distance (x) between branches can be as little as 0.5 times the mounting height.

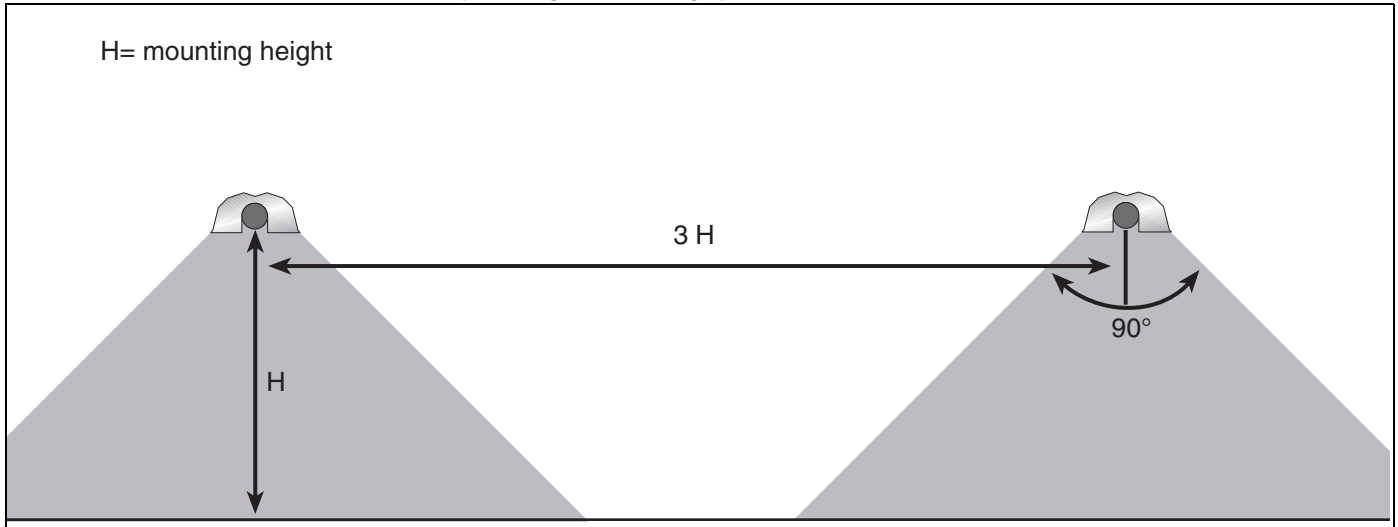
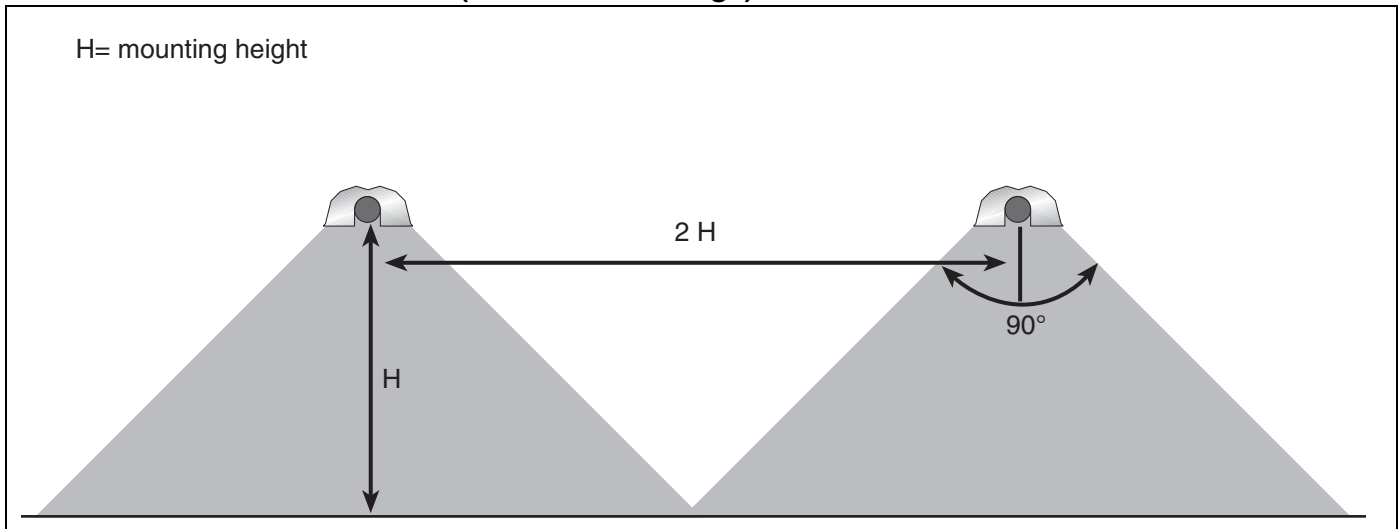
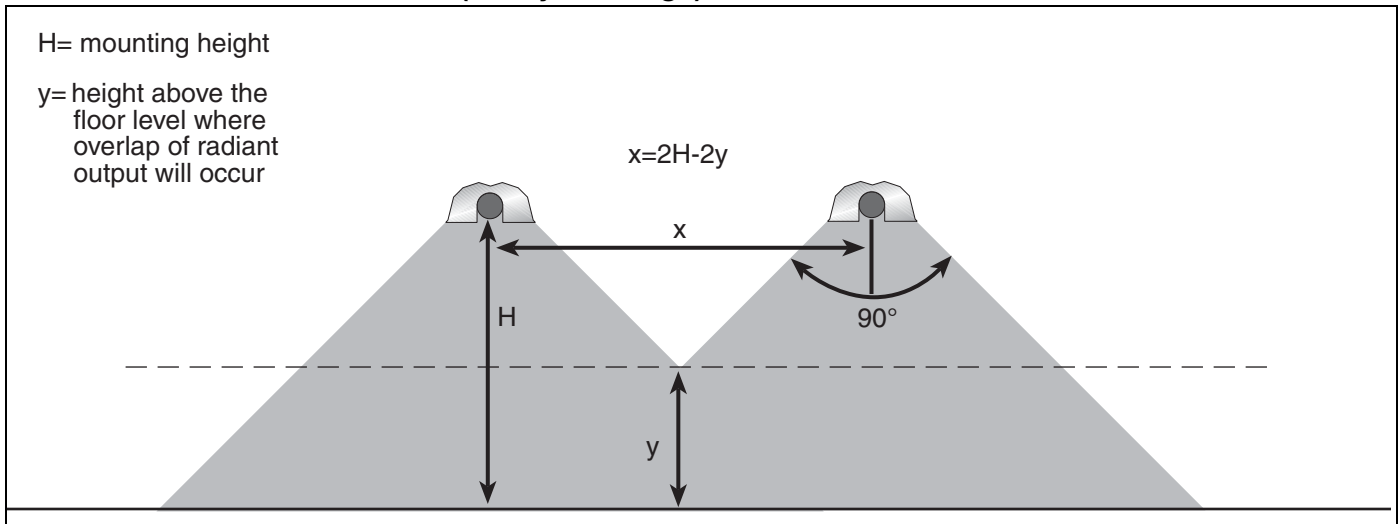
FIGURE 11: Radiant Distribution (Average Coverage)**FIGURE 12: Radiant Distribution (Increased Coverage)****FIGURE 13: Radiant Distribution (Heavy Coverage)**

SECTION 5: FLOW LOADING

The patented CRV-Series burner system allows a number of burners to be installed in-series, in the same radiant tube, resulting in a long, continuous radiant emitting surface to give even heat distribution within the building.

To enable the burners to be correctly located within the system, to maintain system operating vacuum and obtain design flue gas temperatures at the pump, the design layout is based on a simplified flow principle using a “flow unit.”

The flow unit is defined as the amount of fuel/air mixture for a heat input of 10,000 (Btu/h). This corresponds to a flow rate of 1.83 cfm at 65-70°F (18-21°C).

For the purpose of design, flow units enter the CRV-Series system in one of two ways:

- Through the burner.
- Through the end vent plate.

Flow units exit the system as spent products of combustion via the pump.

The purpose of the end vent air is to dilute the hot combustion gases at the burner, thereby promoting uniform heating of the tube while avoiding excessive heating of the combustion chamber.

For the end burner, the burner inlet flow consists of the end vent air and combustion air. For all other

burners, the burner inlet flow consists the of the total of the end vent air plus the combustion gases from all upstream burners.

The requirement for minimum burner inlet flow is met if the total flow units entering the combustion chamber meets or exceeds the minimum as shown on *Page 12, Table 1*.

5.1 Radiant Branch Flow

The flow in a radiant branch consists of the end vent flow units plus the flow units of combustion air from all burners. *Page 13, Figure 14* shows a representation of flow units for various types of branches.

The limiting factor for maximum flow in the radiant section has been determined experimentally in terms of the maximum burner inlet flow units that can be tolerated without degradation of combustion characteristics at the last downstream burner. If more than the maximum number of burners are installed per radiant branch, the vacuum loss across the additional burners will increase appreciably.

This maximum flow in the radiant branch can be expressed for each burner firing rate by either a maximum number of burners per branch or the maximum number of flow units. *See Page 12, Table 1*.

Table 1: CORAYVAC® Design Parameters

Burner Model	B-2	B-4	B-6	B-8	B-9*	B-10	B-12A	B-12
Input (Btu/h) x (1000)	20	40	60	80	90	100	110	120
Flow Units per Burner	2	4	6	8	9	10	12	12
Flow Units per End Vent (minimum flow units entering combustion chamber)	6	10	15	20	15	20	20	20
Maximum Number of Burners per Branch	6	4	4	4	2	4	3	3
Maximum Number of Flow Units per Branch	18	26	39	52	33	60	56	56
Radiant Tube Length (average distance between burners)								
Minimum (ft)	10	12.5	20	20	20	30	35	35
Recommended (ft)	15	20	25	30	30	40	50	50
Maximum (ft)	20	25	35	45	50	60	70	70
Minimum Distance from Burner to Downstream Elbow (ft)	5	5	10	10	10	15	15	15
Suggested Minimum mounting Height (ft)	8	8	8	10	10	15	15	15

* CRV B-9 requires first downstream tube from burner to be aluminized heat-treated.

FIGURE 14: Burner Flow Units

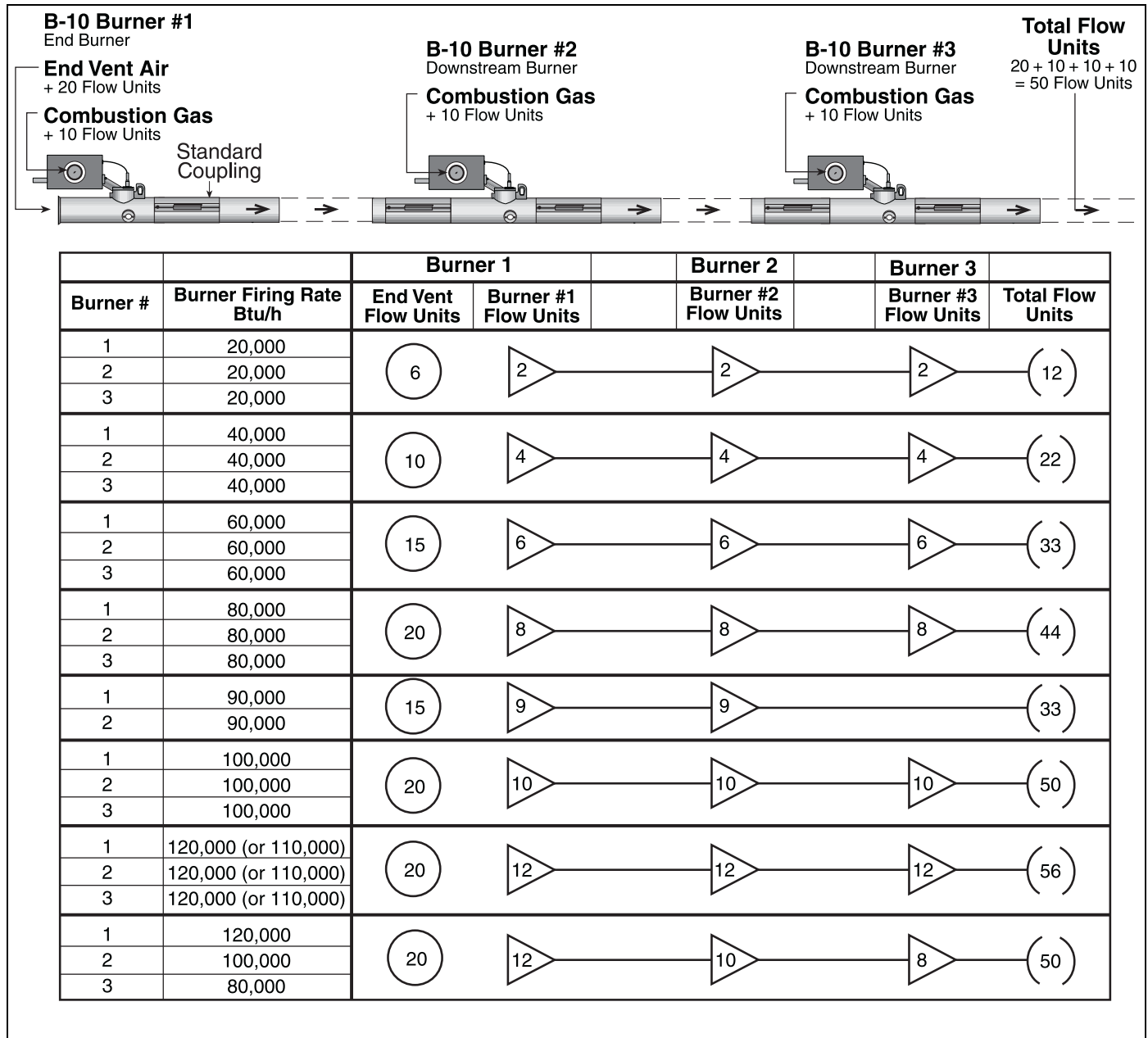

5.2 Pump Capacity

The flow unit capacity of the pump is indicated on Page 14, Table 2, as a function of installed altitude. When the CRV-Series system is designed in accordance with this set of instructions and is in proper operating condition, a vacuum from 2-3" w.c. will be obtainable at each end vent (i.e. at all burners).

Table 2: Pump Capacity

Installed Altitude		Maximum Flow Units		
Feet Above Sea Level	Meters Above Sea Level	EP-100	EP-200 Series	EP-300 Series
0' - 2000'	0 m - 609 m	66	112	224
2001' - 3000'	610 m - 914 m	63	105	215
3001' - 4000'	915 m - 1219 m	60	100	206
4001' - 5000'	1220 m - 1524 m	57	95	197
5001' - 6000'	1525 m - 1828 m	54	90	188
6001' - 7000'	1829 m - 2134 m	51	84	180
7001' - 8000'	2135 m - 2438 m	48	80	170
8001' - 9000'	2439 m - 2743 m	45	75	161

There are a number of design requirements which, if not met, will reduce the vacuum obtainable and thereby the effective flow capacity of the pump. These include:

- **Minimum Length of Tailpipe** - If less than the minimum length of tailpipe is provided per radiant branch, there will be insufficient cooling of the combustion gases and improper operation of the pump.
- **Line Loss Check for Tailpipe** is applicable to sections of tailpipe which are common to two or more radiant branches (i.e. shared lengths). See Page 14, Figure 15.
- **Excessive back pressure** on discharge line of pump can be caused by partial blockage or too much flow for length. See Section 5.3.1
- **More than maximum number of burners** or flow units per radiant branch. See Page 14, Table 2.
- **Excessive number of elbow or tee fittings** which increases vacuum loss.

5.3 Tailpipe Flow

Excessive flow loading in a single section of tailpipe can cause low vacuum and lower effective pump capacity. For the pump to develop the proper vacuum, the length of tailpipe must not be excessive for the

number of flow units carried in the tube.

See Figure 15. Readings for length and flow when plotted on the graph must fall on OK side to avoid excessive vacuum losses.

FIGURE 15: Vacuum Loss Curve for 4" Shared Tailpipe

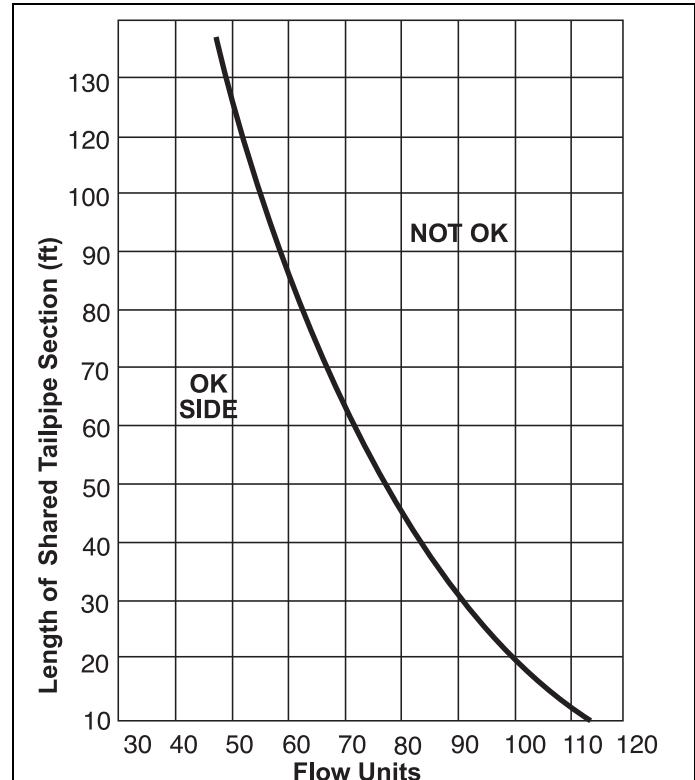

NOTE: For 6" (15 m) tailpipe, length is limited to a maximum of 100' (30 m). See Page 16, Section 6.3 for more details.

Lengths shown include allowance for 1 elbow every 50' (15 m); deduct 15% of length for each additional elbow used per 50' (15 m) length.

5.3.1 Pump Exhaust Length Requirements

The tube length on the exhaust side of the pump is considered excessive if not within the following conditions:

Table 3: Pump Exhaust Requirements

Pump Series	Exhaust Tube Length	Exhaust Tube Diameter
EP-100	Up to 25' (7.6 m)	4" 3 Elbows
EP-100	Up to 50' (15 m)	5" 3 Elbows
EP-200	Up to 10' (3 m)	4" 1 Elbow
EP-200	Up to 25' (7.6 m)	5" 3 Elbows
EP-200	Up to 50' (15 m)	6" 3 Elbows
EP-300	Up to 10' (3 m)	6" 1 Elbow
EP-300	Up to 25' (7.6 m)	7" 3 Elbows
EP-300	Up to 50' (15 m)	8" 3 Elbows

SECTION 6: RADIANT TUBE AND TAILPIPE

The main purpose of the tailpipe and the radiant tube is to provide sufficient tube surface to transfer the heat from the flue gases to the tube wall where it radiates from the tube. **Radiant tube** is defined as the tubing between burners firing in a radiant branch, plus the radiant tubing immediately following the last downstream burner. **Tailpipe** is defined as all tubing between the radiant tube and the pump.

Most of the radiant heat supplied by each burner is released from the radiant tube; the balance is released by the tailpipe. The placement of radiant tube to correspond to areas of major heat loss is the key to providing uniform comfort levels. The use of adequate tailpipe is the key to high combustion efficiency and proper operation of the pump.

6.1 Radiant Tube Length

The considerations in the selection of the length of radiant tube include the following:

6.1.1 Minimum Radiant Tube Length

Provides for the highest level of intensity per length of radiant tube and good radiant heat uniformity between burners. More tailpipe length is required to maintain operating efficiency and pump capacity.

6.1.2 Maximum Radiant Tube Length

Provides the lowest level of intensity per length of radiant tube, and consequently the largest span between burners. The radiant intensity will be reduced slightly for the last 5'-10' (2-3 m) of radiant tube before the next burner.

The length of radiant tube required varies according to the burner input. Consideration has been given to the use of a standard 10' (3 m) length of tube or lengths that can be cut from same without waste. See *Page 12, Table 1*.

When positioning radiant tube to give the required radiant distribution, it is important to consider:

- Clearances to combustible materials.
- Lighting equipment and other suspended objects.

6.2 Tailpipe

Tailpipe provides a low level of radiant intensity per length. The length of tailpipe for systems can be varied according to the flow units in the system and the designed radiant length. Longer lengths of tailpipe will attain higher operating efficiencies and therefore condensation will occur.

Page 16, Figure 16 relates the effect on system thermal efficiency of variations in radiant and tailpipe lengths. The chart was created based on test data obtained in accordance with methodology developed by the National Bureau of Standards (NBSIR 80-2110) and recommendations on flue loss calculation contained in ANSI Z83.20/CSA 2.34 (latest edition). Actual installation variables (gas BTU content, air temperature and operation cycle, etc.) may effect efficiencies (positively or negatively). *Page 16, Figure 16* is presented as a guide to the designer for information only.

NOTE: When accounting for the required tailpipe lengths during the design process, it is important to verify that the tailpipe for each branch is at least equal to the specified minimum.

FIGURE 16: Tube Length vs. Efficiency

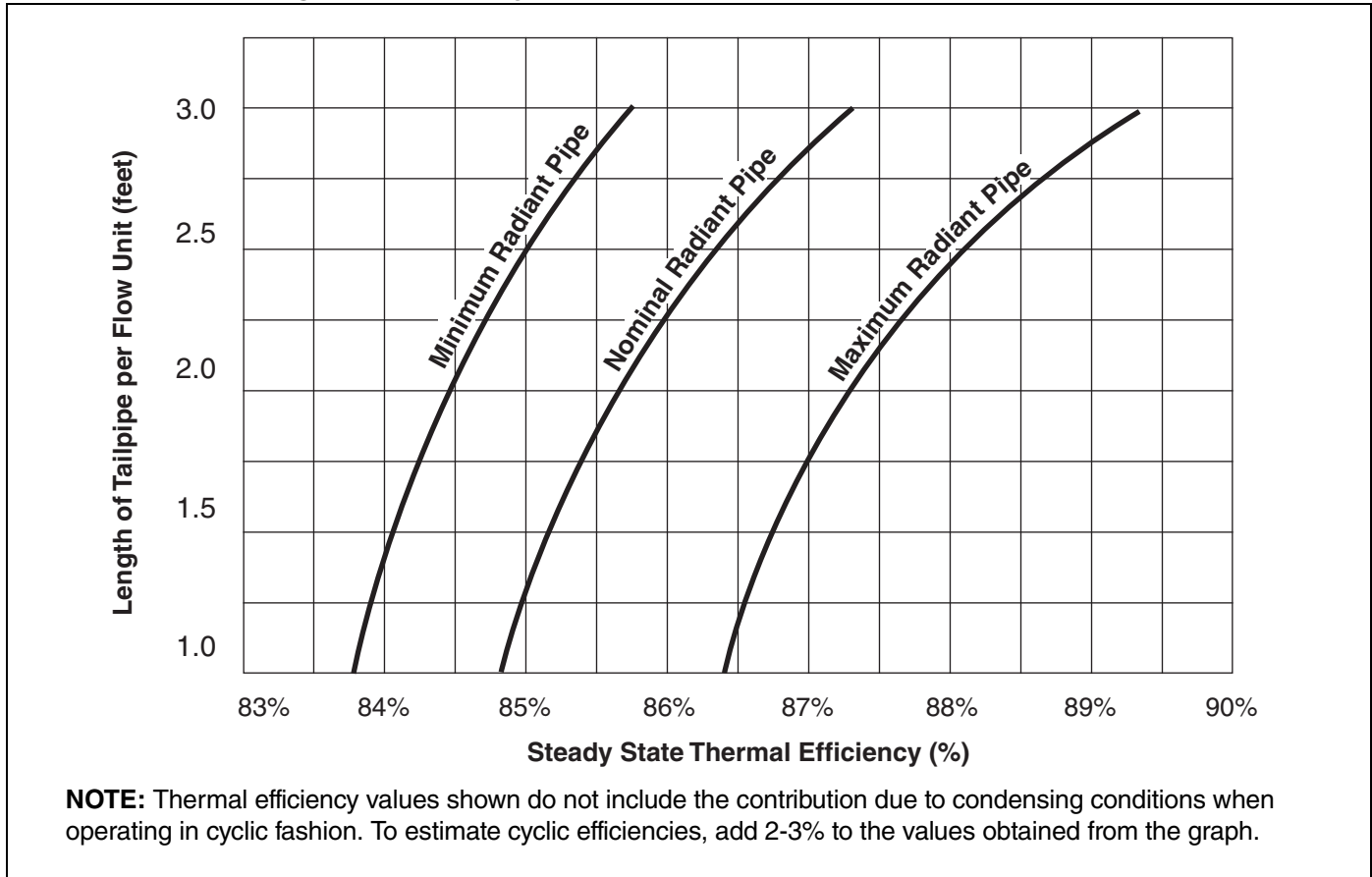

6.3 Design Parameters

When designing branches of 4 B-8 or larger burners in-series, the following limitation to the pump capacity applies:

Pump Model Series Maximum Loading

- EP-100:Not Allowed
- EP-200:1 Branch of 4 burners
- EP-300:2 Branches of 4 burners

For systems that are designed above 90% pump capacity, the following limitations of shared tailpipe apply:

- 4" (10 cm) shared tailpipe: limited to maximum of 2 combined branches and length limited to maximum of 20' (6 m). See Page 14, Figure 15 for all other tailpipe considerations.
- 6" (15 cm) shared tailpipe limited to maximum of 4 combined branches and length limited to maximum of 100' (30 m).
- When calculating required shared tailpipe length 1' (.3 m) of 6" manifold tube is equivalent to 1.3' (.4 m) of 4" shared tailpipe.

Failure to comply with the above parameters will result

in insufficient vacuum to burners.

6.4 CRV-Series Design Methods

1. Layout the system to suit the BTU input required.
2. Calculate the system design for each branch individually.
3. Calculate the number of flow units per branch of burners. Add the flow units for each branch together to get the total system flow units. See Page 12, Table 1 for the rules for each burner model. See Page 13, Figure 14 for example flow unit calculations.

<u>Flow Units Per Branch</u>	
Branch 1	_____ +
Branch 2	_____ +
Branch 3	_____ +
Branch 4	_____ +
Branch 5	_____ +
Branch 6	_____ +
Total System Flow Units =	_____

4. Select pump model series for total system flow units:
 EP-100: up to 66 flow units
 EP-200: up to 110 flow units
 EP-300: up to 224 flow units
5. See Page 14, Table 2 for altitudes greater than 2000'.
6. For each branch, add the length of radiant tube after each heater:

Burner	Radiant Tube Length After Each Burner
1	_____ +
2	_____ +
3	_____ +
4	_____ +
5	_____ +
6	_____ +

Total Radiant Tube
 Length in Branch = _____

Repeat this calculation for each branch in the system.

7. Divide the total radiant tube length in the branch by the number of burners in the branch to get the average radiant length per burner.

Average Radiant
 Length Per Burner = _____

Repeat this calculation for each branch in the system.

8. Using the average radiant length per burner (Calculated in Step 7) See Page 17, Table 4 to select the allowable tailpipe lengths per flow unit.

Table 4: Allowable Tailpipe Lengths

	Burner Model						
	B-2	B-4	B-6	B-8	B-9	B-10	B-12/B-12A
Radiant Tube Length (average distance between burners)							
Minimum (ft)	10	12.5	20	20	20	30	35
Recommended (ft)	15	20	25	30	30	40	50
Maximum (ft)	20	25	35	45	50	60	70
Tailpipe length per flow unit							
Minimum (ft)*	1.2	1.2	1.2	1.2	1.2	1.2	1.2
Recommended (ft)	1.5	1.5	1.5	1.5	1.5	1.5	1.5
Maximum (ft)	2.5	2.5	2.5	2.5	2.5	2.5	2.5
Maximum (ft) for EP-100 only	1.7	1.7	1.7	1.7	1.7	1.7	1.7

*Minimum tailpipe lengths can only be used if radiant tube length is recommended or greater.

EXAMPLE 3: B-10 Radiant Tube vs. Tailpipe Length

For a B-10 burner system of 200 flow units and an average of 40' radiant tube length per burner, See Page 17, Table 4 for the tailpipe lengths per flow unit that can be used and the corresponding operating characteristic.

From Table 4, we can use between 1.2' per flow unit and 2.5' per flow unit when the average radiant length per B-10 burner is 40'. By multiplying the number of flow units in the system (200 flow units) by the minimum tailpipe length from the chart (1.2' per flow unit), we see that we will need a minimum of 240' of tailpipe for this system. Likewise, by multiplying the number of flow units in the system (200 flow units) by the maximum tailpipe length from the chart (2.5' per flow unit), we see that maximum system, tailpipe length is 500'.

Tailpipe length range for a B-10 burner system with 200 flow units and an average radiant tube length of 40' is 240'-500'. The length of the tailpipe will determine whether the system is condensing or non-condensing. Given a certain radiant tube length and tailpipe length, the operating characteristic can be determined using Table 5.

Table 5: Operating Characteristics; Condensing or Non-Condensing

	Tailpipe Length per Flow Unit			
	Minimum	Recommended	1.7 ft/flow unit	Maximum
Radiant Tube Length (average distance between burners)				
Minimum	N/A	NC	Borderline	C
Recommended	NC	Borderline	C	C
Maximum	Borderline	C	C	C

N/A=Not Allowed NC=Non Condensing C=Condensing

6.5 Tailpipe Design Method

Given the overall length of tailpipe for the system, the following section provides the method for ensuring the design will function correctly.

Total tailpipe _____ ' (includes 1 elbow / 50').

6.5.1 Rule of Thumb Unshared Calculations

$$\frac{\text{Total tailpipe} - 10'}{\text{Number of branches}} = \text{Optimum unshared tailpipe per branch}$$

Select a pump discharge location and plan the route of the tailpipe. For example system layouts See Page 21, Figure 18 through Page 25, Figure 26 for different pump and system efficiency requirements. If these layouts are not suitable, it is necessary to customize the layout for the CRV-Series system to the individual building requirements.

For multiple branch systems, always plan to connect the unshared tailpipe together as close to the pump as possible for better system efficiency.

6.5.2 Shared Tailpipe Calculation

System with EP-100 or EP-200 Series Pump

See Page 14, Figure 15 for maximum permissible length of tailpipe for the number of flow units entering

the section of tailpipe.

If flow units entering a shared tailpipe system exceed 90% of pump capacity, the length of 4" diameter shared tailpipe must not exceed 20'.

System with EP-300 Series Pump

For shared tailpipe up to 115 flow units, 4" diameter tailpipe can be used. See Page 14, Figure 15 for maximum permissible length of tailpipe for the number of flow units entering the section of tailpipe.

Shared tailpipe greater than 115 flow units use 6" diameter tube. Note that all tailpipe lengths for the purposes of calculation are expressed in terms of 4" diameter tube.

Effective length: 10' (3 m) of 6" (15 cm) diameter tube = 13' (4 m) of 4" diameter tube.

6.5.3 To Calculate the Total System Tailpipe

Total unshared tailpipe + shared 4" branch tailpipe + effective length of shared 6".

6.5.4 To Check Performance Criteria

$$\frac{\text{Total system tailpipe}}{\text{Total flow units}} = \text{Tailpipe ft/flow unit}$$

Compare the results to Page 17, Table 4 and Page 18,

Table 5 for the burner model to ensure that the resulting tailpipe lengths maintain intended operating characteristic.

6.5.5 Damper Couplings

Damper couplings are needed:

- In any tailpipe branch that carries less flow units than other tailpipe branches connected to the same pump
- In unsymmetrical layouts with branches having the same number of flow units, the damper coupling is placed in every branch except for the longest branch.

The purpose of the damper coupling is to adjust the end vent vacuum down to the desired level. These are to be placed in the tailpipe section and not the radiant branch. The recommended location is before the first tee fitting or 10'-40' from the end of the radiant pipe.

See Page 20, Figure 17; Page 23, Figure 21, Page 24, Figure 25, and Page 25, Figure 26 for placement examples.

FIGURE 17: Possible Damper Coupling Locations

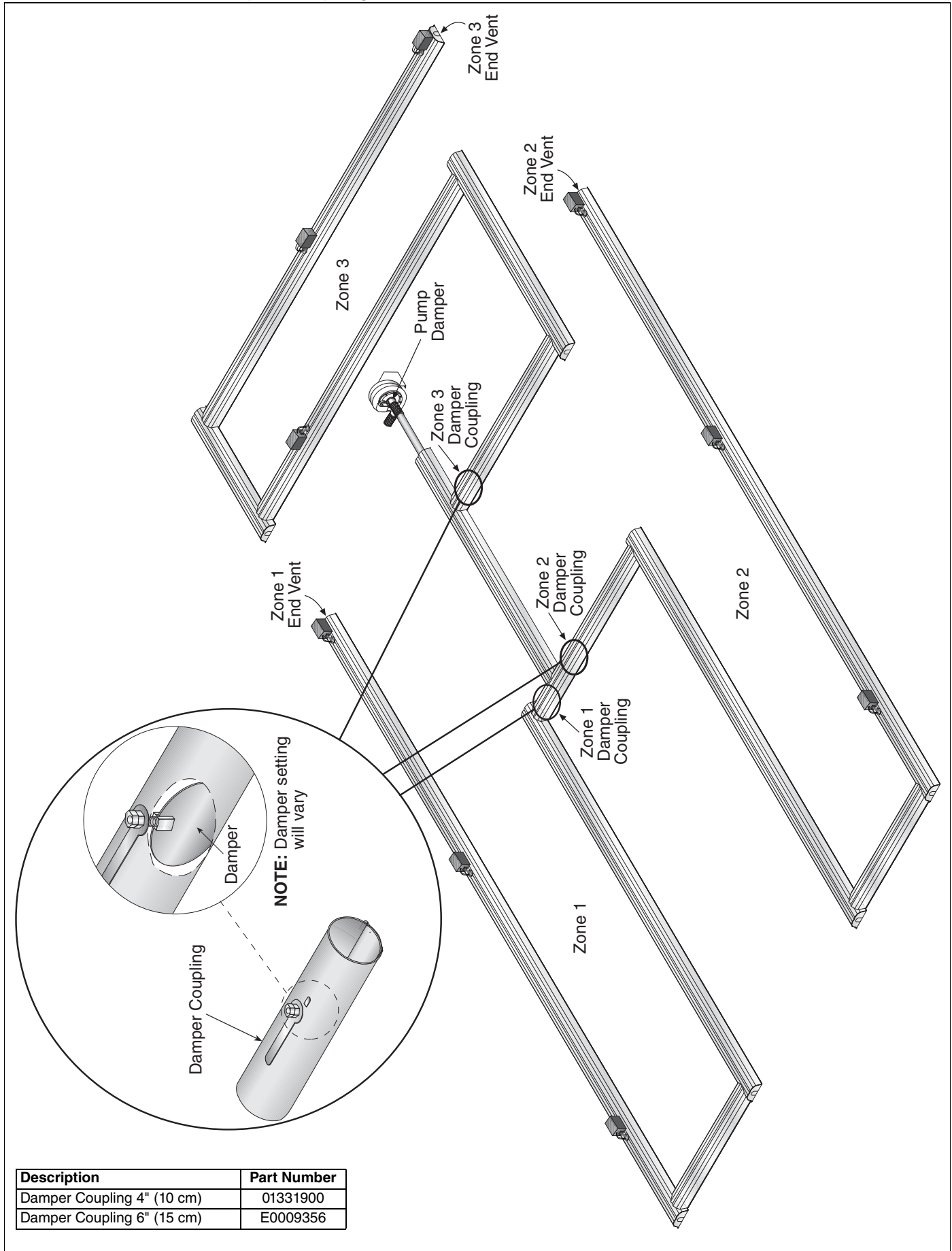

SECTION 7: EXAMPLE CRV-SERIES SYSTEM LAYOUTS

Systems that are symmetrical are preferred because the vacuum available in the system branches are balanced as a function of design (damper couplings are not needed).

Where radiant tube lengths are variable in a single branch, the average length shall be used to determine the total radiant tube length. Tailpipe will begin after the last radiant tube following the last burner in the branch.

CRV-Series is most effective when there are at least 3 burners in the radiant branch.

To assist with the selection of burners and system designs, the following figures show system layouts that have been used extensively with CRV-Series since 1962. Designing systems using these layouts will mean altering the dimensions to suit the individual building.

Generally, shared tailpipe reduces the available system vacuum. See Page 14, Section 5.3 for shared tailpipe design rules.

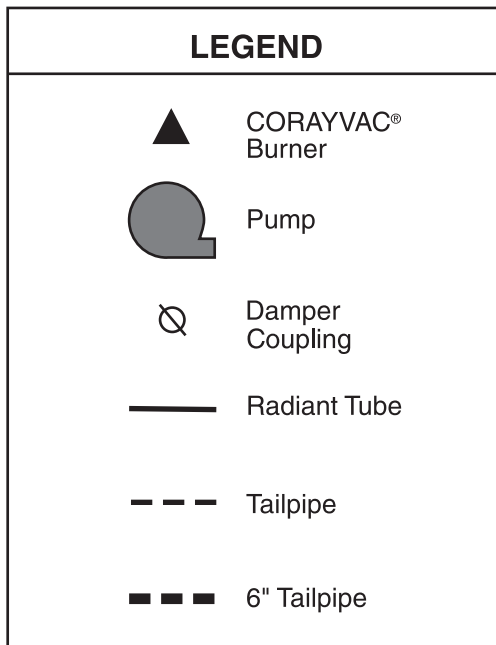
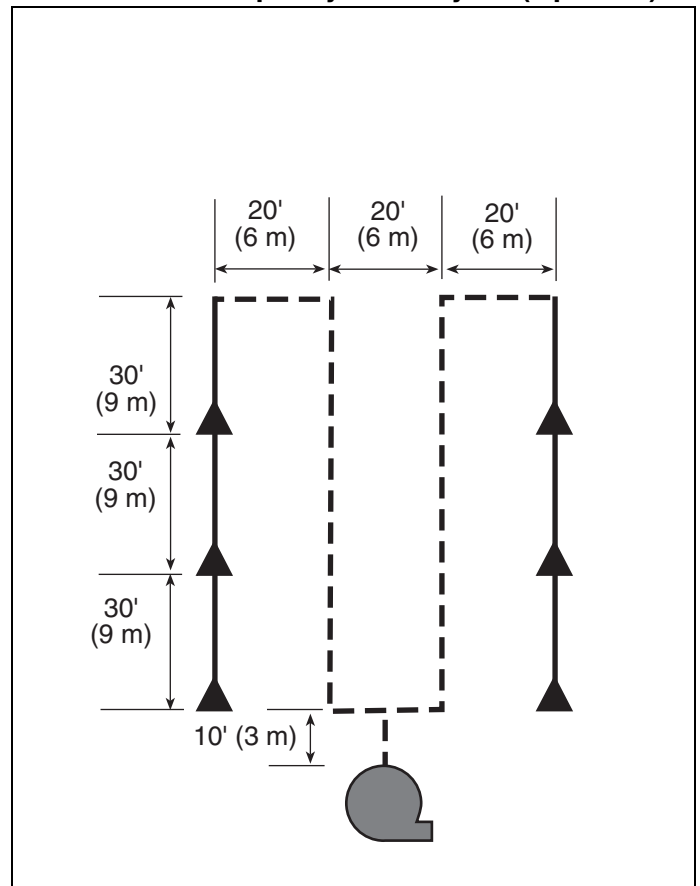

FIGURE 18: Example System Layout (Option 1)



7.1 Example System Layout (Option 1)

Six B-10 burners at minimum radiant tube length and 2.5 ft/flow unit tailpipe, the recommended pump for this system is an EP-200 Series pump.

This system provides maximum radiant intensity on the left and right and adds supplemental radiant effects through the center creating very even radiant effects over the coverage area.

Layout to provide high system efficiency, condensed radiant output and good uniformity of distribution. Adjust the lengths as necessary for different input systems and to change the efficiency levels.

FIGURE 19: Example System Layout (Option 2)

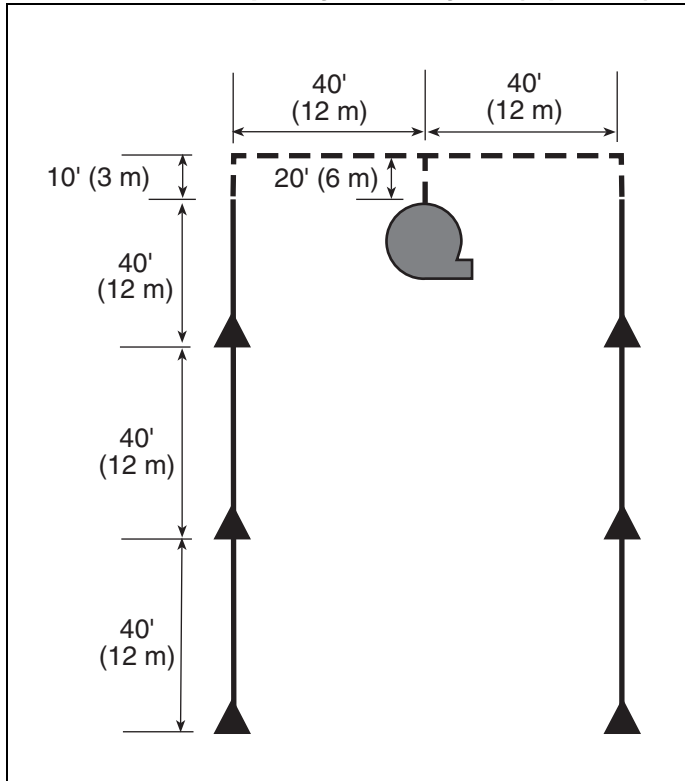

7.2 Example System Layout (Option 2)

Six B-10 burners at recommended radiant tube length and 1.2'/flow unit tailpipe, the recommended pump for this system is an EP-200 Series pump.

Layout will minimize up front equipment cost of tubing by implementing minimum tailpipe length.

Layout will exhibit minimum system efficiency. Adjust the lengths as necessary for different input systems and to increase the efficiency levels.

FIGURE 20: Example System Layout (Option 3)

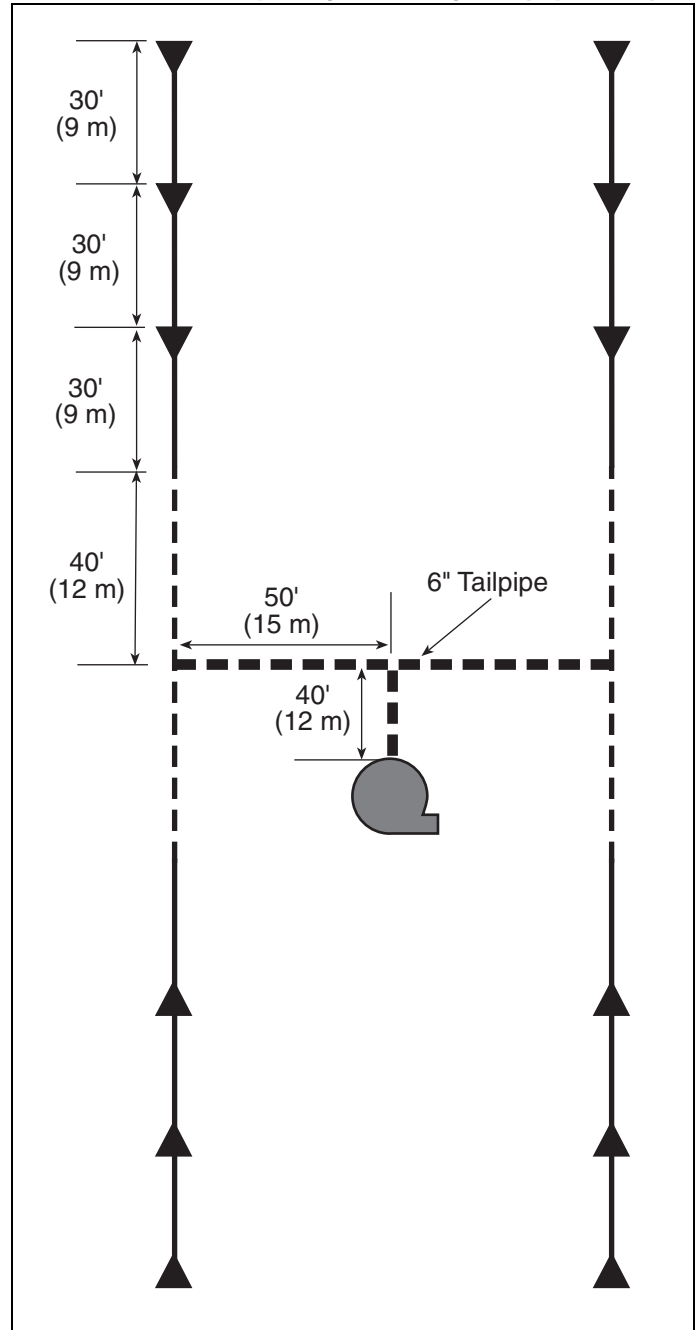

7.3 Example System Layout (Option 3)

Twelve B-10 burners at minimum radiant tube length and 1.56'/flow unit tailpipe, the pump for this system is an EP-300 Series Pump.

All shared tailpipe is 6" diameter.

Layout will provide maximum radiant intensity between burners.

Layout will exhibit minimum system efficiency. Adjust the lengths as necessary for different input systems and to increase the efficiency levels.

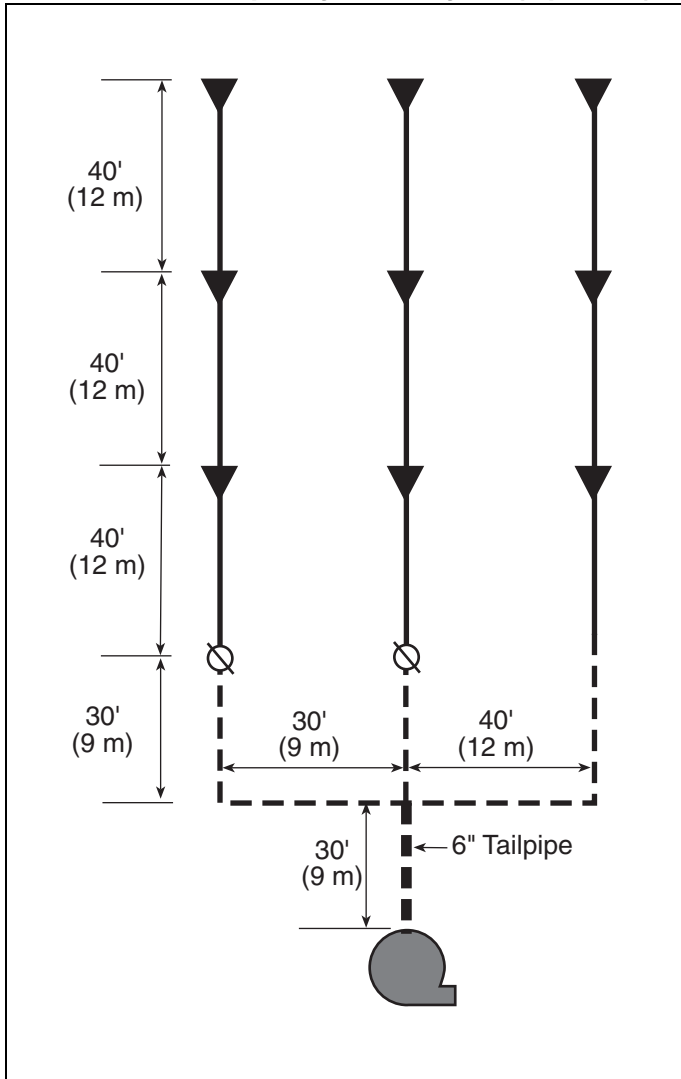
FIGURE 21: Example System Layout (Option 4)**7.4 Example System Layout (Option 4)**

Nine B-10 burners at recommended radiant tube length and 1.58'/flow unit tailpipe, the pump for this system is an EP-300 Series Pump.

All shared tailpipe is 6" diameter.

Layout will exhibit nominal system efficiency. Adjust the lengths as necessary for different input systems and to increase the efficiency levels.

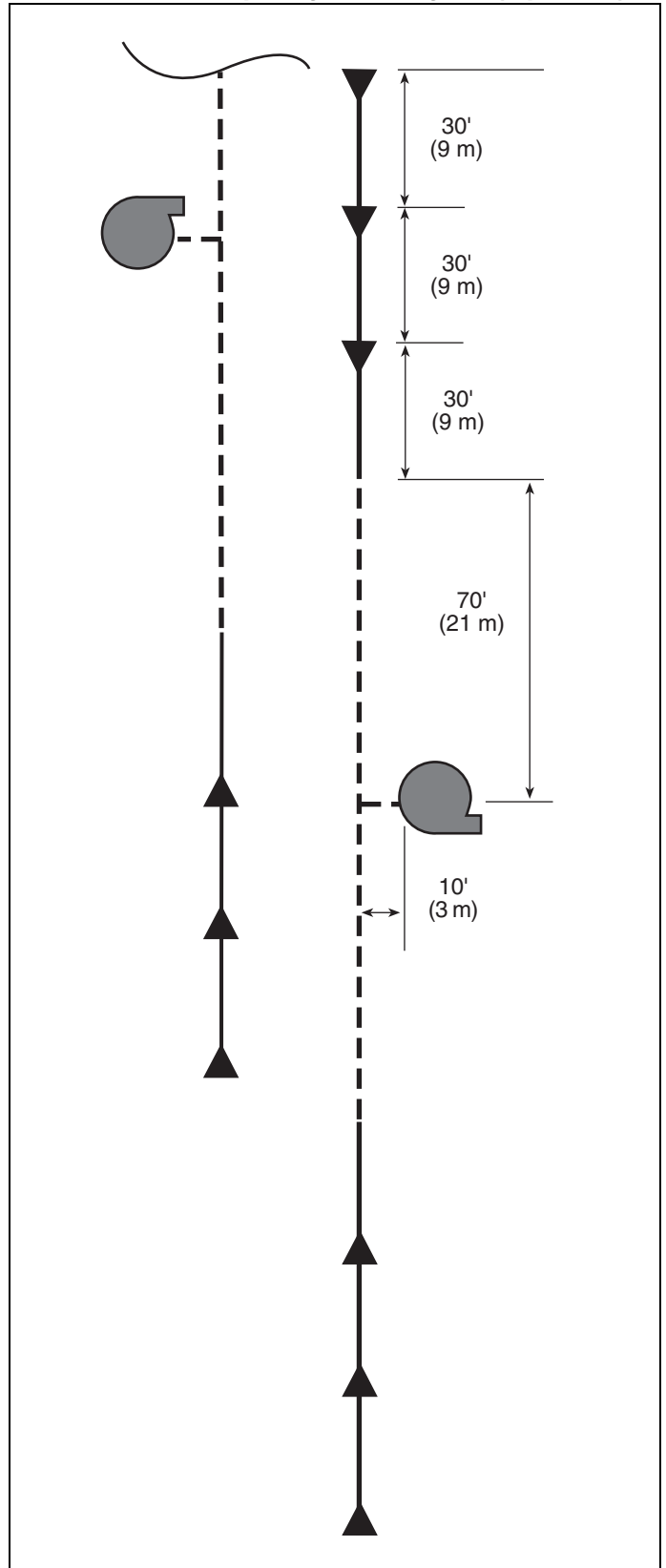
FIGURE 22: Example System Layout (Option 5)**7.5 Example System Layout (Option 5)**

Six B-10 burners at minimum radiant tube length and 1.5'/flow unit tailpipe, the pump for this system is an EP-200 Series pump.

Layout to provide minimum system efficiency. Adjust the lengths as necessary for different input systems and to increase the efficiency levels.

This system is generally accompanied by an additional system, as shown, so that the radiant output of the additional system supplements the lack of radiant intensity from the tailpipe of the first system. This layout method is used in high heatloss and perimeter heating applications.

FIGURE 23: Example System Layout (Option 6)

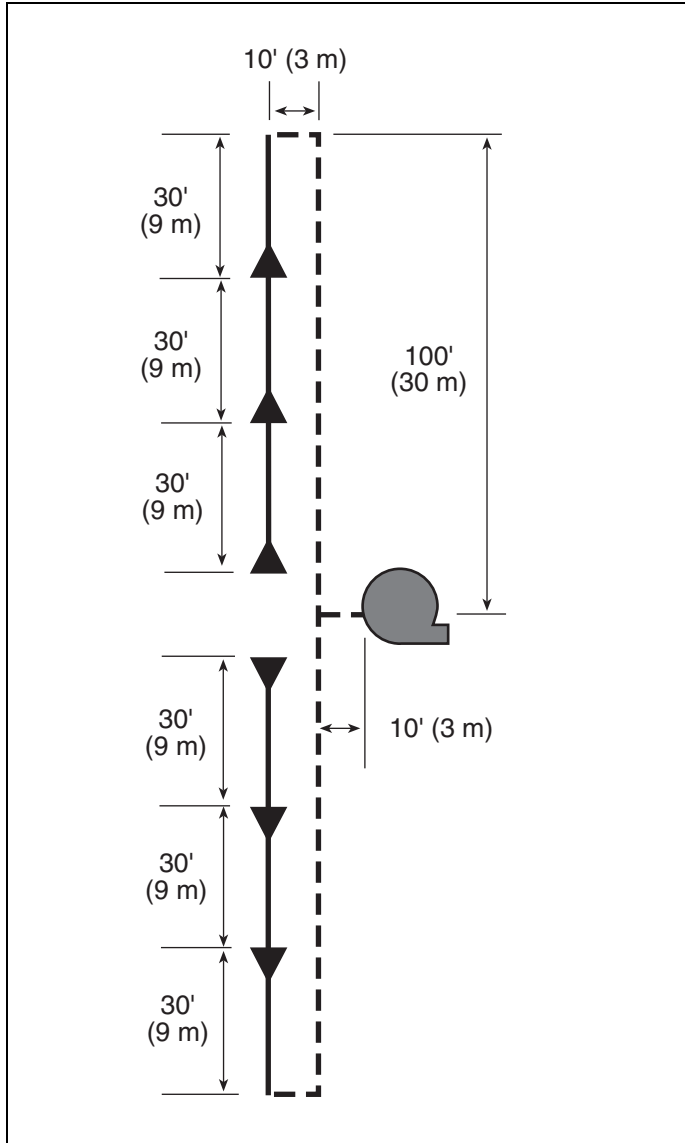

7.6 Example System Layout (Option 6)

Six B-10 burners at minimum radiant tube length and 2.3' flow unit tailpipe, the pump for this system is an EP-200 Series pump.

Layout to provide high system efficiency, condensed radiant output and good uniformity of distribution. Adjust the lengths as necessary for different input systems and to change the efficiency levels.

This layout method is often used effectively in heatloss and perimeter heating applications.

FIGURE 24: Example System Layout (Option 7)

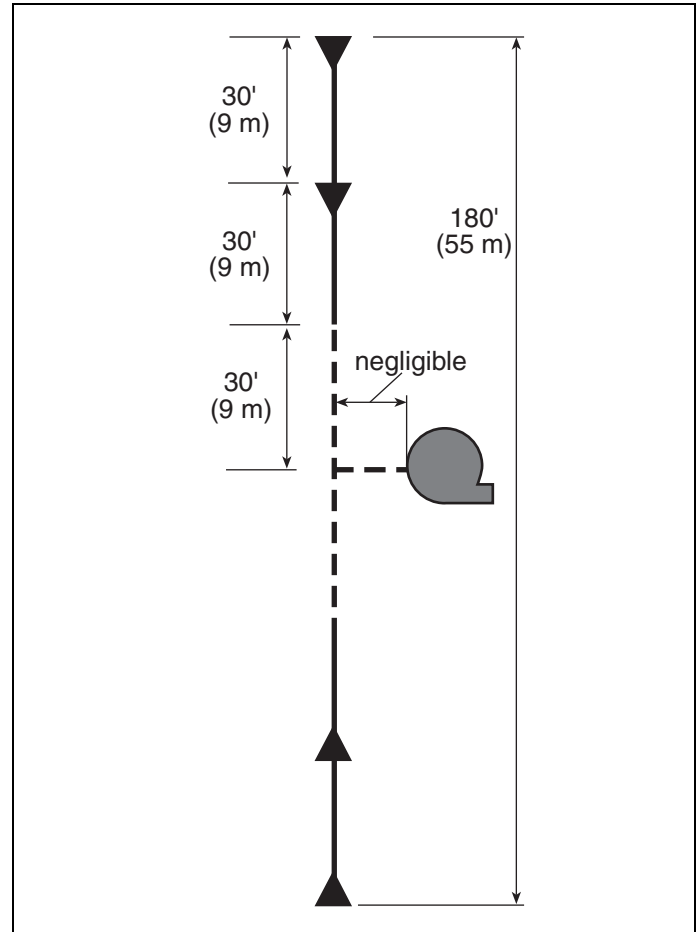

FIGURE 25: Example System Layout (Option 8)

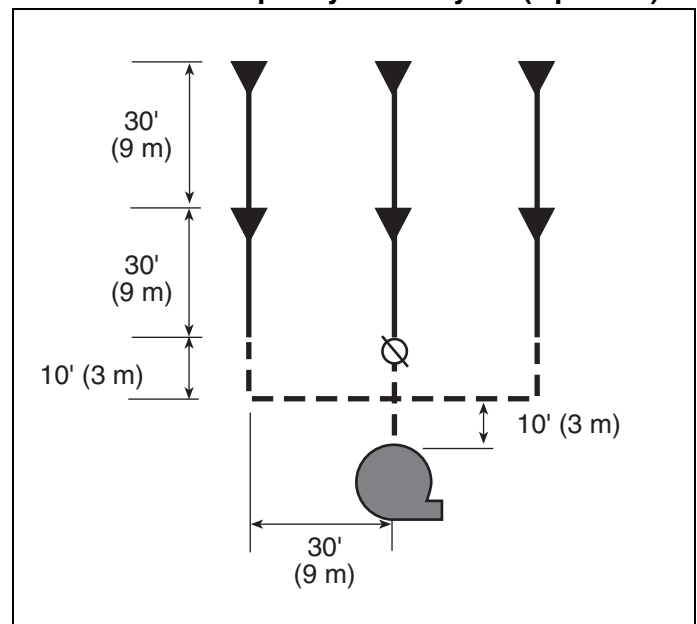
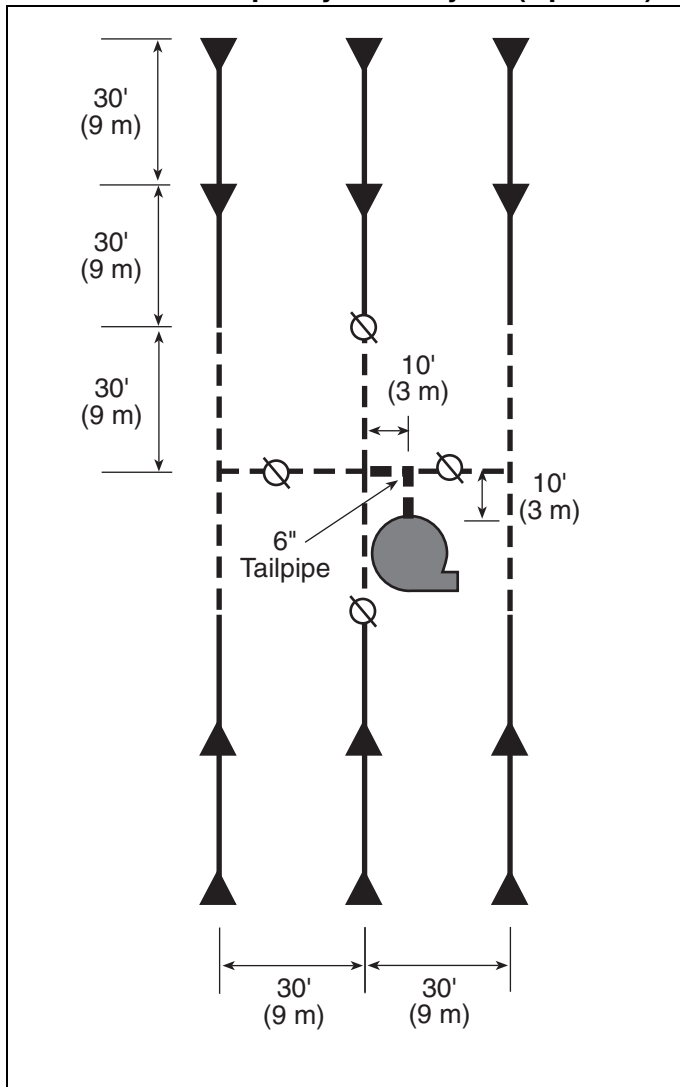

FIGURE 26: Example System Layout (Option 9)

Layout to provide condensed radiant output and good uniformity of distribution. Layout will exhibit minimum system efficiency.

7.7 Example System Layout (Option 7, 8 and 9)

These systems are for B-9 burners only, this burner is specially rated for 2 burners in-series applications in the systems shown.

Option 7 is a 180' (55 m) straight system connected to an EP-100 pump.

Option 8 is a system connected to an EP-200 Series pump.

Option 9 is a system connected to an EP-300 Series pump.

These layouts show minimum allowed lengths. Additional tubing may be added. The distance between the burners can be varied from 30' (9 m) to 20' (6 m), but the overall system lengths must remain the same.

Layout will minimize upfront equipment cost of tubing by implementing special shortened minimum tailpipe lengths.

SECTION 8: CONTROL METHODS

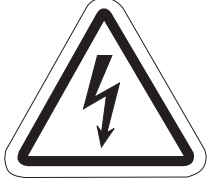
⚠ DANGER

Electrical Shock Hazard
Disconnect electric before service or maintenance.
More than one disconnect switch may be required to disconnect electric to the unit.
Control must be properly grounded to an electrical source.
Failure to follow these instructions can result in death or electrical shock.

⚠ WARNING

Explosion Hazard
Turn off gas supply to heater before service.
Failure to follow these instructions can result in death, injury or property damage.

There are several methods of controlling CRV-Series systems. The options are as follows:

8.1 ROBERTS GORDON® CORAYVAC® Heating Control

The CORAYVAC® Heating Control is an electronic control panel designed to control CRV-Series heating systems.

The CORAYVAC® Heating Control can be used to control an EP-100 or EP-201 pump from the control panel. Other pumps such as the EP-301 and 3 Ø models may be controlled in conjunction with a relay or motor starter. The CORAYVAC® Heating Control can control up to four zones of burners and up to two vacuum pumps.

The electrical circuit is a 120 Vac (20 A) supply.

The output for the thermostat is 24 Vac.

A CORAYVAC® Heating Control operated system has

two minutes post purge pump operation to completely exhaust products of combustion from the system. A CORAYVAC® Heating Control provides indication of power to the pump and zones and indicates the status of the pressure switch with lights. The CORAYVAC® Heating Control is ETL listed in accordance with UL873 – Standard for Temperature Indicating and Regulating Equipment.

8.2 CORAYVAC® Modulating Heating Control (CRV-B 6/8/9/10/12/12A only)

The CORAYVAC® Modulating Heating Control is a micro-processor based control package designed for modulating control of CRV-Series heaters based on outdoor temperatures. The controls offer full modulation between 60% and 100% of system maximum rated input.

This controller is capable of giving control outputs to two pumps and four heating zones. The controller also features inputs which are used for indoor and outdoor signal condition monitoring.

System status and settings are viewed and altered from a touchscreen.

Special design requirements apply for CRV-Series systems using the CORAYVAC® Modulating Heating Control.

Buildings today demand all sorts of control options based on the user's preference. CORAYVAC® Modulating Heating Control offers a host of communication options for integration with controls' networks to best serve individual needs:

8.3 CORAYVAC® Modulating Thermostat

Another way to modulate a ROBERTS GORDON® CORAYVAC® Modulating system, combine a modulating thermostat, a thermostat relay (P/N 90417600K) and any one of the existing ROBERTS GORDON® VFD assemblies. The result will be a one pump, one zone CORAYVAC® Modulating system.

The system will modulate based on the temperature sensed at the modulating thermostat, not outdoor temperature. The modulating controls offer many features like 7 day programmability, four time periods per day (2 occupied, 2 unoccupied), temporary temperature setpoint override, keypad lockout security and more.

Remote sensors or outdoor sensors are optional, not required. Remote sensors will allow for zone temperature averaging, if required.

8.3.1 Analog Signal Modulating Thermostat

A programmable, 7-day programming, modulating thermostat can be installed to supply an analog (4-20mA) or (2-10Vdc with 500 Ohm resistor) control signal to dictate the speed of the pump. Optional

room sensors (P/N 10081520) and outdoor air sensors (P/N 10081521) are available.

Room temperature averaging networks can be created with up to nine room sensors (P/N 10081520). Refer to thermostat installation instructions for wiring.

8.3.2 Analog Signal Modulating Thermostat with LonWorks® Communication

If LonWorks® communication is required, a modulating thermostat can be installed to supply an analog (4-20 mA or 2-10 Vdc) signal to control the pump speed. An optional room sensor (P/N 10081520) and outdoor air sensors (P/N 10081521) are available for this thermostat as well.

The modulating thermostat with LonWorks® provides networking capability in a LonWorks® system. With communications port running at 78 kilobits per second (kbs), this thermostat can be configured to perform a variety of activities in which data is sent or received via LonWorks®. Information that can be shared, viewed and modified with the network includes:

- Current year, month, day, hour, minute, second.
- System Mode.
- Space Temperature
- Outdoor air temperature
- Current setpoint
- Occupied/Unoccupied schedule commands.
- Space Temperature

8.3.3 Analog signal Modulating with BACnet® Programmable Thermostat

If BACnet® communication is required, a BACnet® enabled modulating thermostat can be installed to supply an analog output (0-10VDC) signal control to dictate the speed of the pump.

This thermostat is a flexible, wall-mounted stand-alone control with combined controller/sensor. BACnet® connections allow integral peer to peer BACnet® MS/TP LAN network communications with configurable baud rates and can easily integrate with a building automation system.

MS/TP Wiring

Connect the -A terminal in parallel with all other -A terminals on the network and the +B terminal in parallel with other +B terminals. Connect the shield of cable (Belden cable #82760 or equivalent).

Connect the cable shield to a good earth ground **at one end only**.

8.4 SPST Transformer Relay Kit (P/N 90417600K)

The transformer relay can be used to control an EP-100 or EP-201 pump CORAYVAC® system. The single pole relay can only be used to control one zone of burners. The electrical circuit is a 120 V AC (20 A) supply. The transformer 24 V AC output for the thermostat is rated at 40 V A. Thermostats used with the transformer must not exceed this power requirement.

A transformer relay operated system will not give any post purge pump operation to completely exhaust products of combustion from the system or provide indication of operating conditions.

8.5 SPDT Transformer Relay (P/N 90436300)

The transformer relay can be used to control an EP-100 or EP-201 pump CORAYVAC® system. The double pole relay can only be used to control two zones of burners. The electrical circuit is a 120 V AC (20 A) supply. The transformer 24 V AC output for the thermostat is rated at 40 VA. Thermostats used with the transformer must not exceed this power requirement. A transformer relay operated system will not give any post purge pump operation to completely exhaust products of combustion from the system or provide indication of operating conditions.

8.6 Pressure Switch

A pressure switch is required to confirm pump operation on all systems.

A pressure switch is also required on the inlet duct of a non-pressurized air supply.

SECTION 9: AIR SUPPLY SYSTEM

An air supply free of dust and corrosive contaminants is essential for proper operation and best life expectancy with any heating system. With CRV-Series, there are two alternatives available to the designer for providing the air supply. These are:

- Room air, a filter is standard for each burner.
- Outside air system to duct air from an uncontaminated source. The outside air system can be designed as a pressurized or non-pressurized system.

The first alternative above is usable when the dust load is not excessive and there is no usage of corrosive contaminants such as solvents or vapors inside the building.

The outside air system must be used in all applications where corrosive contaminants may be present in the air even in trace amounts (few parts per million).

It is important for designers and owners of heating systems to note that the presence of contaminants in the combustion air supply will greatly accelerate the rate of corrosion on tube surfaces and will shorten the useful life of the heating system. This is true regardless of whether the heating system is CRV-Series, other infrared systems or conventional gas or oil-fired equipment such as unit heaters, central boiler plant, etc.

With the unique vacuum powered burners, the fuel/air mix remains constant, even if combustion air filters are dirty. It can be expected that the use of an outside air system will reduce but not eliminate the potential for corrosion due to contamination.

In a way similar to the CRV-Series pump system, the design of the air supply system also involves considerations of total flow units and acceptable combinations of duct lengths (and diameters) versus flow units carried. In certain circumstances, it may be desirable to introduce an outside air blower to pressurize the system. A small positive pressure is desirable and necessary to prevent the system from drawing in contaminated air.

9.1 Pressurized

For pressurized outside air supplies, the outside air blower motor has a pressure switch that must be used. Wire this switch in-series with the pump pressure switch. When using an outside air blower with a ROBERTS GORDON® CORAYVAC® Heating Control,

CORAYVAC® Modulating Heating Control or relay transformer, a separate load relay package is required. Wire the control for the relay in parallel with the pump. The outside air blower must have a separate 20 A, 120 V power supply.

9.2 Non-Pressurized

For a non-pressurized outside air supply, a 4" O.D. single wall pipe duct may be attached to the burner and end vent. For length and duct sizing requirements See *Section 9.3*. To prevent condensation, insulate the outside air duct.

9.3 Outside Air System Design Requirements

9.3.1 Non Pressurized

- 6" diameter duct must not exceed 90' (27 m)
- 4" diameter duct must not exceed 90' (27 m)
- Elbows are equivalent to 10' (3 m) of duct length.
- See the CRV-Series Installation, Operation, and Service Manual (P/N 127102NA) for ducting installation details.

9.3.2 Pressurized Systems

- 6" diameter duct must not exceed 120' (36 m) total per system.
- 4" diameter duct must not exceed 120' (36 m) per radiant branch.
- See the CRV-Series Installation, Operation, and Service Manual (P/N 127102NA) for ducting installation details.

FIGURE 27: Air Supply System Capacity by Duct Length and Diameter

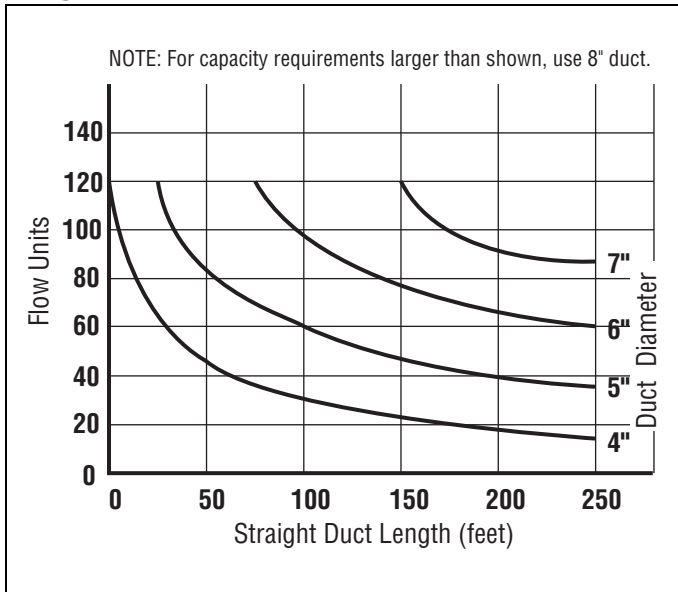

9.3.3 Pipe sizing

To size each section of pipe proceed as follows:

- Calculate the required flow units at each outlet of the supply system.
- Measure the longest run of pipe from the blower to the most remote outlet. Use only this distance in *Figure 27* (or the next longer distance if the exact distance is not shown). This is to provide assurance that the pressure drop to the most remote outlet will not exceed 0.25" w.c. when all outlets are supplied.
- See *Figure 27*, find the intersection point on the graph for the appropriate duct length and number of flow units. The duct size above this intersection point indicates what size duct work should be used. Proceed in a similar manner for each outlet and each section of duct. For each section of duct, determine the total flow unit capacity supplied by that section.

Duct Design Rules

- System should be designed so that the blower is positioned closest to the highest flow requirements (end vents).
- When a duct is carrying more than 40 flow units, it must be at least 6" diameter.

Blower (P/N 90707501K) Performance 112 Flow Units:

One outside air blower is required per each EP-100 or

EP-200 series pump and two outside air blowers may be required for each EP-300 series pump. Outside air blowers cannot be shared between two separate CRV-Series systems.

FIGURE 28: Outside Air Blower

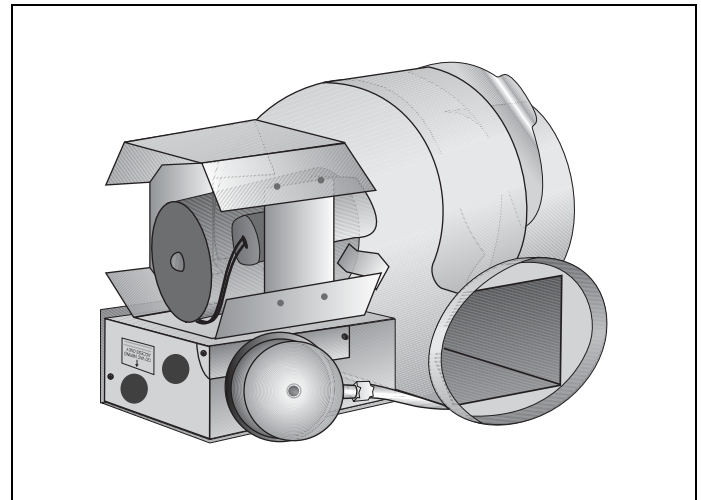
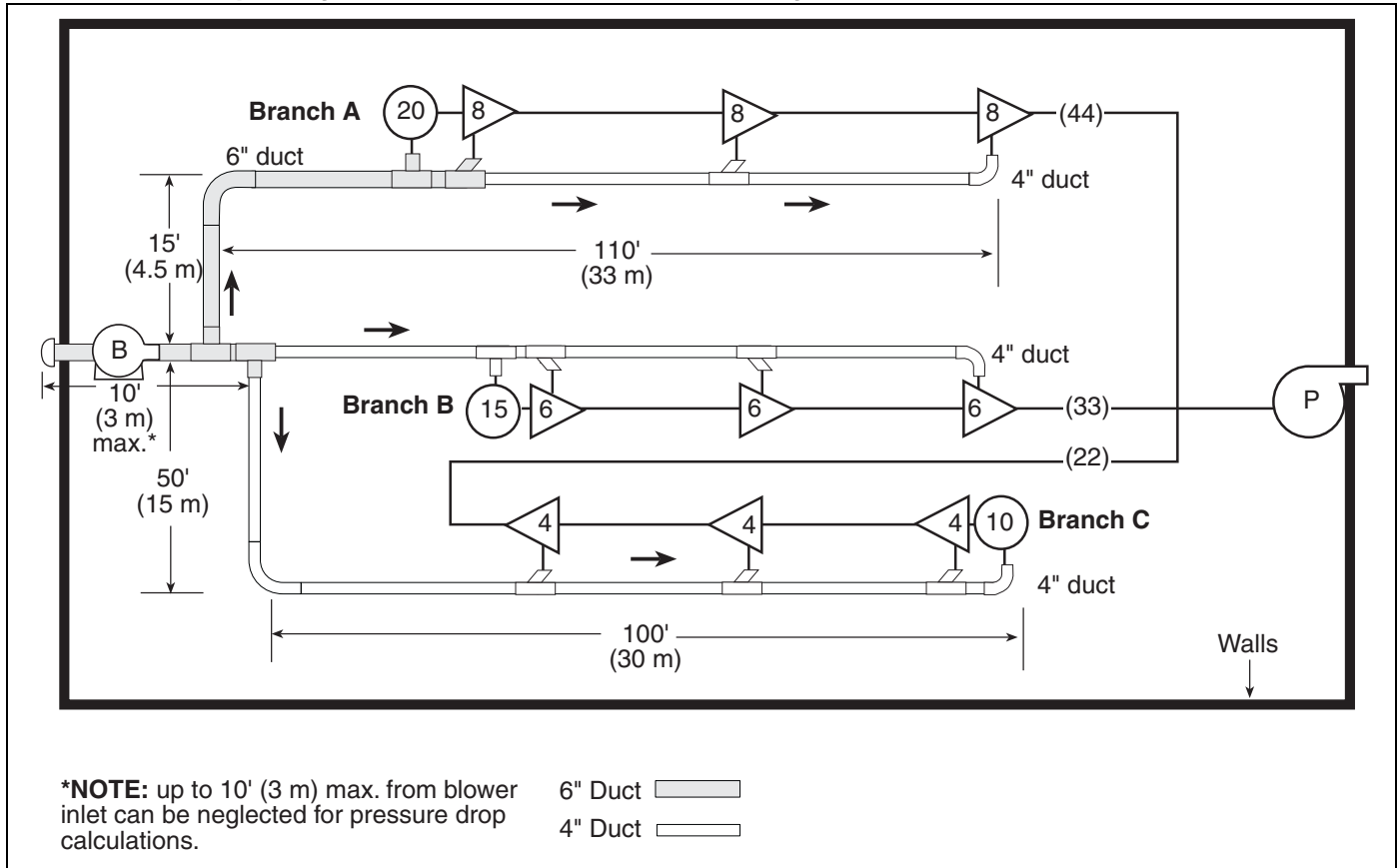

FIGURE 29: Sample Layout for Pressurized Outside Air Systems



SECTION 10: CORAYVAC® MODULATING HEATING CONTROL DESIGN REQUIREMENTS

CRV-B-2 and CRV-B-4 are not available for use with CORAYVAC® Modulating Heating Control.

CRV-Series systems designed with **minimum** radiant tube length shall have 1.5' - 2.0' per flow unit of tailpipe length.

-OR-

CRV-Series systems with **recommended** radiant tube length shall have 1.2' - 1.5' per flow unit of tailpipe length.

SECTION 11: CRV-SERIES EQUIPMENT SPECIFICATIONS

The total heating system supplied shall be design certified by the CSA International per American National Standard ANSI Z83.20/CSA 2.34 (latest edition).

11.1 Burner and Burner Controls

11.1.1 Burners shall be designed to operate simultaneously in series without adverse effects from combustion gases from upstream burners.

11.1.2 Burners shall be capable of firing on: Natural Gas, or LP Gas.

11.1.3 Burners shall be supplied to fire at any one of the input firing rates as specified:

CRV-B-2-20,000 (Btu/h)

CRV-B-4-40,000 (Btu/h)

CRV-B-6-60,000 (Btu/h)

CRV-B-8-80,000 (Btu/h)

CRV-B-9-90,000 (Btu/h)

CRV-B-10-100,000 (Btu/h)

CRV-B-12A-110,000 (Btu/h)

CRV-B-12-120,000 (Btu/h)

When using CORAYVAC® Modulating Heating Control controls, burner rates will modulate between 60% and 100% rated input (CRV-B-2 and CRV-B-4 are not available for use with CORAYVAC® Modulating Heating Control controls).

11.1.4 The design of burners supplied shall provide for maintaining a constant proportion of fuel gas to filtered combustion air. These conditions are met for burners in which the pressure of both the fuel gas and the combustion air are introduced at zero (atmospheric) pressure and the flow of each is established by a vacuum on the downstream side of the flow metering orifices.

11.1.5 To assure a high degree of fail-safe operation, the design shall preclude flow of gas if any or all of the following abnormal conditions occur in the non-firing mode:

1. Main valve fails in open position.
2. Vacuum pump motor fails to operate.
3. Power fails.

11.1.6 To further assure a high degree of safety, the system will be under negative pressure at all times during operation to preclude the possibility of the escape of combustion gases inside the building.

11.1.7 The burner control assembly will include a zero regulator.

11.1.8 All burners shall be pre-wired with a grounded electrical cord and plug.

11.2 Equipment

11.2.1 Burner

Each burner assembly shall consist of heavy-duty cast-iron burner heads, pre-wired gas controls with electronic, three-try direct spark ignition and combustion air filter.

11.2.2 Pump

The pump model supplied will vary with the capacity of the system. See the pump technical specification sheet or the installation, operation and service manual for product description and specification.

The pump shall be acoustically isolated from the system with a flexible connector with temperature rating of 350°F (177°C) minimum. The motor in the vacuum pump shall be secured with rubber mounts for acoustical isolation.

11.2.3 Heat Exchanger

Radiant tubing (between burners and 10' - 70' downstream of last burner) shall be of 4" O.D. steel or heat treated aluminized tubing.

As an option, the balance of the tubing shall be 4" O.D. steel tubing with an internal and external coating of acid-resistant porcelain.

All heat exchanger (tubing) connections shall be made with stainless steel coupling assemblies. Standard couplings will be used in radiant sections. Lined couplings will be used in tailpipe sections.

11.2.4 Outside Air

When specified, in contaminated environments, the system shall be capable of supplying air from the outside to each burner and end vent for the support of combustion.

Attach this information to a wall near the ROBERTS GORDON® heater.

ROBERTS GORDON®

Infrared Heating

Read the Installation, Operation, and Service Manual thoroughly before installation, operation, or service.

Know your model number and installed configuration.

Model number and installed configuration are found on the burner and in the Installation, Operation and Service Manual.

Write the largest clearance dimensions with permanent ink according to your model number and configuration in the open spaces below.

OPERATING INSTRUCTIONS

1. STOP! Read all safety instructions on this information sheet.
2. Open the manual gas valve in the heater supply line.
3. Turn on electric power to the heater.
4. Set the thermostat to desired setting.

TO TURN OFF THE HEATER

1. Set the thermostat to off or the lowest setting.

IF THE HEATER WILL NOT OPERATE, TO ENSURE YOUR SAFETY, FOLLOW THESE INSTRUCTIONS TO SHUT DOWN YOUR HEATER

1. Set the thermostat to off or the lowest setting.
2. Turn off electric power to the heater.
3. Turn off the manual gas valve in the heater supply line.
4. Call your registered installer/contractor qualified in the installation and service of gas-fired heating equipment.

⚠ WARNING



Fire Hazard

Keep all flammable objects, liquids and vapors the minimum required clearances to combustibles away from heater.

Some objects will catch fire or explode when placed close to heater.

Failure to follow these instructions can result in death, injury or property damage.

**Maintain _____ clearance
to the side and
_____ clearance below
the heater from vehicles
and combustible materials.**

Roberts-Gordon LLC
1250 William Street
P.O. Box 44
Buffalo, NY 14240-0044 USA
Telephone: +1.716.852.4400
Fax: +1.716.852.0854
Toll Free: 800.828.7450

Installation Code and Annual Inspections:

All installation and service of ROBERTS GORDON® equipment must be performed by a contractor qualified in the installation and service of equipment sold and supplied by Roberts-Gordon and conform to all requirements set forth in the ROBERTS GORDON® manuals and all applicable governmental authorities pertaining to the installation, service, operation and labeling of the equipment. To help facilitate optimum performance and safety, Roberts-Gordon recommends that a qualified contractor conduct, at a minimum, annual inspections of your ROBERTS GORDON® equipment and perform service where necessary, using only replacement parts sold and supplied by Roberts-Gordon.

Further Information: Applications, engineering and detailed guidance on systems design, installation and equipment performance is available through ROBERTS GORDON® representatives. Please contact us for any further information you may require, including the Installation, Operation and Service Manual.

This product is not for residential use.

© 2015 Roberts-Gordon LLC

All rights reserved. No part of this work covered by the copyrights herein may be reproduced or copied in any form or by any means – graphic, electronic, or mechanical, including photocopying, recording, taping, or information storage and retrieval systems – without written permission of Roberts-Gordon LLC.

www.robertsgordon.com

P/N 91037912 Rev. K